

TIG



Spare Parts List 2.0 / V1



Copyright

All texts, pictures, drawings and other information published in the spare parts list are subject to the copyright protection of Alexander Binzel Schweisstechnik GmbH & Co. KG, Germany – unless otherwise marked.

Any reproduction, even in part, is only allowed with the express written permission of Alexander Binzel Schweisstechnik GmbH & Co. KG, Germany.

Content

- **About us ...**
- **TIG Welding Torches "ABITIG® GRIP" 9 – 26, "ABITIG® GRIP Little" 9 – 24 W**
air and liquid cooled Chapter 1
- **TIG Welding Torches "ABITIG® GRIP" 150 – 450 W,**
"ABITIG® GRIP Little" 150 – 260 W air and liquid cooled Chapter 2
- **Component kits** Chapter 3
- **Handles and control modules "BIS"** Chapter 4
- **Cable assembly components "BHS"** Chapter 5
- **Connecting modules "BCS"**
Single- and central connectors Chapter 6
- **Control line plugs "BLS"** Chapter 7
- **Hose connections "BHC"**
Power, gas and water Chapter 8
- **TIG Welding Torches "ABITIG®" with rotary valve**
air cooled Chapter 9
- **TIG Automatic Welding Torches "ABITIG®-MT"**
air and liquid cooled Chapter 10
- **Cold Wire Feeder System "ABIDRIVE-CW" and**
"ABITIG® GRIP" Welding Torches with cold wire feed
liquid cooled Chapter 11
- **Spare Parts List (numerical)** Chapter 12
- **Standard Terms and Conditions of Deliveries and Services**

About us ...



A global leader.

With more than 850 employees, 30 production and sales companies, as well as over 20 exclusive partners, Alexander Binzel Schweißtechnik GmbH & Co. KG, founded in 1945, is one of the global leaders in arc welding and torch engineering.

In addition to the high quality product range, the company offers comprehensive individual solutions for welding-related production. Defined market attributes and guarantees for worldwide market success are: R&D strengths, high quality products, engineering expertise and our international sales, consulting and service network.

Trading partners and users all over the world can avail of a dedicated office and field consulting and support team.



Quality. Made by ABICOR BINZEL.

Our products are manufactured according to Binzel standards and international directives. Certificated according to DIN EN ISO 9001.

Innovation. Today and in future.

ABICOR BINZEL has its own R&D. Our modern laboratories cooperate with innovative science, research and industry experts throughout the world.



Global Player. Proximity to the customers – everywhere.

Worldwide proximity to the customers is one of the success points of the quality brand ABICOR BINZEL. In the last years the network of our subsidiaries and representatives was considerably widened. This ensures the global consulting, service and supply competence in the most important industrial countries. Further-on the worldwide coverage of the costumers with original parts and accessories is guaranteed.



Original brand name quality. Internationally represented in:

 Egypt	 Israel	 Spain
 Argentina	 Italy	 South Africa
 Australia	 Japan	 South Korea
 Belgium	 Canada	 Thailand
 Brazil	 Latvia	 Czech Republic
 Bulgaria	 Lithuania	 Turkey
 China	 Luxembourg	 Ukraine
 Denmark	 Mexico	 Hungary
 Germany	 Netherlands	 USA
 England	 Norway	 Venezuela
 Estonia	 Austria	 United Arab Emirates
 Finland	 Poland	 Vietnam
 France	 Romania	 Belarus
 Greece	 Russia	 Cyprus
 India	 Sweden	
 Indonesia	 Switzerland	
 Iran	 Singapore	
 Iceland	 Slovakia	





TIG Welding Torches

ABITIG® GRIP

air and liquid cooled

“The universal solution”

ABITIG® GRIP - the complete solution in the field of TIG Welding Torches. This range represents a logical development of the ABITIG®-Torch range, which has distinguished itself by its consistent implementation of modular design and optimum ergonomics.

The torches in various ratings, both air and liquid cooled, are fitted with a uniform ergonomic handle with “GRIP” and optimised cable assembly management, into which numerous switch and control functions can be integrated. All consumables are compatible to the international “SR-Standard”.

The flexible cable assemblies are available with modular and robust machine-side connections.

- One ergonomic handle with “GRIP” for all ABITIG® GRIP torch types - offers high gripability and optimum feel
- Modular switching and control functions integrated into the handle - individually and ergonomically
- Short ball joint for optimum movement radius and ideal handling
- Light and flexible cable assemblies with modular machine-side connections for all available TIG welding power sources
- Consumables compatible to the international standard

Technical data (EN 60 974-7)

TIG Welding Torches “ABITIG® GRIP” (air cooled)

Type	Rating (A)		Duty cycle (%)	Tungsten electrode-Ø (mm)
	DC	AC		
ABITIG® GRIP 9 / F	110	80	35	0.5 - 1.6
ABITIG® GRIP 17 / F	140	100	35	0.5 - 2.4
ABITIG® GRIP 24 G	110	80	35	0.5 - 1.6
ABITIG® GRIP 26 / F / K	180	130	35	0.5 - 4.0

F=Flexible. K=Short. Subject to change without notice.

TIG Welding Torches “ABITIG® GRIP” (liquid cooled)

Type	Rating (A)		Duty cycle (%)	Tungsten electrode-Ø (mm)
	DC	AC		
ABITIG® GRIP 12-1	350	250	100	1.6 - 4.0
ABITIG® GRIP 18 / F / K	320	230	100	0.5 - 4.0
ABITIG® GRIP 18 SC	400	280	100	0.5 - 4.8
ABITIG® GRIP 20	240	170	100	0.5 - 3.2
ABITIG® GRIP 24 W	140	100	100	0.5 - 2.4

F=Flexible. K=Short. Subject to change without notice.

TIG Welding Torches

ABITIG® GRIP Little

air and liquid cooled

"Compact & Flexible"

The welding torch line ABITIG® GRIP Little – particularly suited to those everyday, less accessible welding jobs. Maximum flexibility with no compromises.

The torches of various ratings, both air and liquid cooled, are combined with a standardized ergonomic handle with "GRIP" and optimised cable assembly management, into which standard switching and control functions can be integrated. All consumables are compatible to the international "SR-Standard".

In addition the flexible cable assemblies are available with modular and robust machine-side connections.

- One ergonomic handle with "GRIP" for all ABITIG® GRIP torch types – offers high gripability and optimum feel
- Modular switching and control functions integrated into the handle
- Excellent protection against high frequency flashover
- Light and flexible cable assemblies (High-Flex-Leather) with modular machine-side connections for all available TIG welding power sources
- Consumables compatible to the international standard
- Air cooled up to 140 A – at 35% duty cycle
- Liquid cooled up to 220 A – at 100% duty cycle

Technical data (EN 60 974-7)

TIG Welding Torches "ABITIG® GRIP Little" (air cooled)

Type	Rating (A)		Duty cycle (%)	Tungsten electrode-Ø (mm)
	DC	AC		
ABITIG® GRIP Little 9 / F	110	80	35	0.5 - 1.6
ABITIG® GRIP Little 17 / F	140	100	35	0.5 - 2.4
ABITIG® GRIP Little 24 G	110	80	35	0.5 - 1.6

F=Flexible. Subject to change without notice.

TIG Welding Torches "ABITIG® GRIP Little" (liquid cooled)

Type	Rating (A)		Duty cycle (%)	Tungsten electrode-Ø (mm)
	DC	AC		
ABITIG® GRIP Little 20 / F	220	150	100	0.5 - 3.2
ABITIG® GRIP Little 24 W	140	100	100	0.5 - 2.4

F=Flexible. Subject to change without notice.

TIG Welding Torches ABITIG® GRIP 9 / 20 – ABITIG® GRIP Little 9 / 20

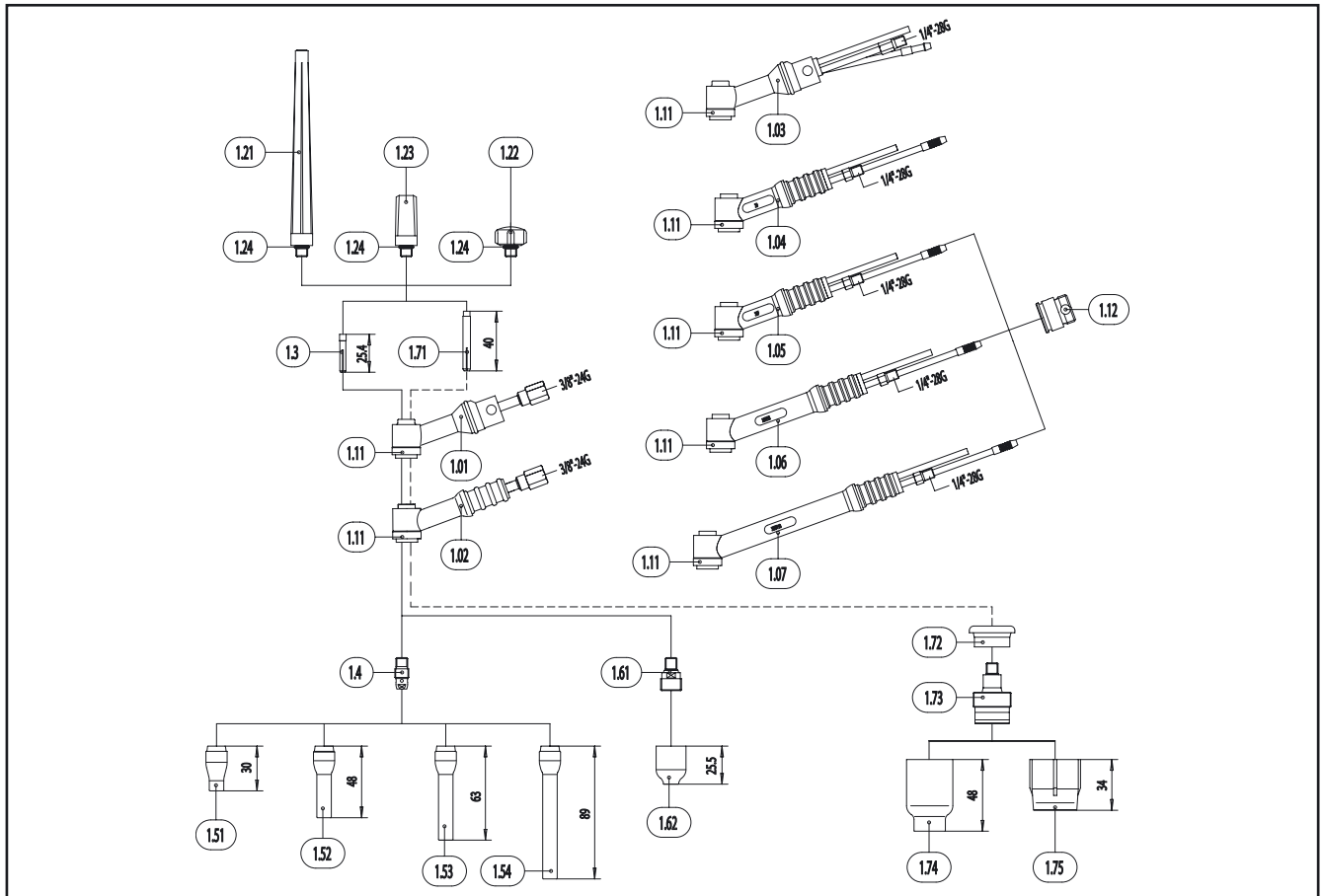

Pos.	Description	Units	Part-No.	Product-group
Torch body				
1.01	Torch body ABITIG® GRIP 9; 46.0 mm long		712.5020	2002
w/o. fig.	Torch body ABITIG® GRIP 9 F (flexible); 46.0 mm long		712.5030	2002
1.02	Torch body SR / ABITIG® GRIP Little 9; 46.0 mm long		705.0001	2002
w/o. fig.	Torch body SR / ABITIG® GRIP Little 9 F (flexible); 46.0 mm long		703.0001	2002
1.03	Torch body ABITIG® GRIP 20; 46.0 mm long		712.3020	2002
w/o. fig.	Torch body ABITIG® GRIP 20 F (flexible); 46.0 mm long		712.3030	2002
1.04	Torch body SR / ABITIG® GRIP Little 20; 46.0 mm long		705.0058	2002
1.05	Torch body SR / ABITIG® GRIP Little 20 F (flexible); 46.0 mm long		703.0302	2002
1.06	Torch body SR / ABITIG® GRIP Little 20 F (flexible); 75.0 mm long		703.0305	2002
1.07	Torch body SR / ABITIG® GRIP Little 20 F (flexible); 110.0 mm long		703.0306	2002
1.11	Insulating ring	10 Pcs.	702.0055	2003
w/o. fig.	Shrink hose Ø 19.1 mm	60 m	104.0007	4050
1.12	Socket		712.7026	2005
Wear parts				
1.21	Back cap, long; (41V24)	10 Pcs.	701.0247	2009
1.22	Back cap, short; (41V33)	10 Pcs.	701.0240	2009
1.23	Back cap, medium; (41V35)	10 Pcs.	701.0244	2009
1.24	O-Ring 4.6x2	20 Pcs.	165.0028	9010
1.3	Collet for electrode Ø 0.5 mm; 25.4 mm long; (13N20)	10 Pcs.	701.0249	2007
1.3	Collet for electrode Ø 1.0 mm; 25.4 mm long; (13N21)	10 Pcs.	701.0250	2007
1.3	Collet for electrode Ø 1.2 mm; 25.4 mm long	10 Pcs.	701.0254	2007
1.3	Collet for electrode Ø 1.6 mm; 25.4 mm long; (13N22)	10 Pcs.	701.0251	2007
1.3	Collet for electrode Ø 2.0 mm; 25.4 mm long	10 Pcs.	701.0255	2007
1.3	Collet for electrode Ø 2.4 mm; 25.4 mm long; (13N23)	10 Pcs.	701.0252	2007
1.3	Collet for electrode Ø 3.2 mm; 25.4 mm long; (13N24)	10 Pcs.	701.0253	2007
1.3	Collet for electrode Ø 0.5 mm; 25.4 mm long; (brass)	10 Pcs.	701.1060	2007
1.3	Collet for electrode Ø 1.0 mm; 25.4 mm long; (brass)	10 Pcs.	701.1061	2007

TIG Welding Torches ABITIG® GRIP 9 / 20 – ABITIG® GRIP Little 9 / 20

Pos.	Description	Units	Part-No.	Product-group
1.3	Collet for electrode Ø 1.2 mm; 25.4 mm long; (brass)	10 Pcs.	701.1027	2007
1.3	Collet for electrode Ø 1.6 mm; 25.4 mm long; (brass)	10 Pcs.	701.1019	2007
1.3	Collet for electrode Ø 2.4 mm; 25.4 mm long; (brass)	10 Pcs.	701.1020	2007
1.3	Collet for electrode Ø 3.2 mm; 25.4 mm long; (brass)	10 Pcs.	701.1063	2007
1.4	Collet body for electrode Ø 0.5 - 1.0 mm; (13N26)	10 Pcs.	701.0275	2008
1.4	Collet body for electrode Ø 1.2 mm	10 Pcs.	701.0279	2008
1.4	Collet body for electrode Ø 1.6 mm; (13N27)	10 Pcs.	701.0276	2008
1.4	Collet body for electrode Ø 2.0 mm	10 Pcs.	701.0280	2008
1.4	Collet body for electrode Ø 2.4 mm; (13N28)	10 Pcs.	701.0277	2008
1.4	Collet body for electrode Ø 3.2 mm; (13N29)	10 Pcs.	701.0278	2008
1.51	Ceramic gas nozzle; no. 4; Ø 6.5 mm; 30.0 mm long; (13N08)	10 Pcs.	701.0281	2004
1.51	Ceramic gas nozzle; no. 5; Ø 8.0 mm; 30.0 mm long; (13N09)	10 Pcs.	701.0282	2004
1.51	Ceramic gas nozzle; no. 6; Ø 9.5 mm; 30.0 mm long; (13N10)	10 Pcs.	701.0283	2004
1.51	Ceramic gas nozzle; no. 7; Ø 11.0 mm; 30.0 mm long; (13N11)	10 Pcs.	701.0284	2004
1.51	Ceramic gas nozzle; no. 8; Ø 12.5 mm; 30.0 mm long; (13N12)	10 Pcs.	701.0285	2004
1.51	Ceramic gas nozzle; no. 10; Ø 16.0 mm; 30.0 mm long; (13N13)	10 Pcs.	701.0286	2004
1.52	Ceramic gas nozzle; no. 4; Ø 6.5 mm; 48.0 mm long; (796F71)	10 Pcs.	701.0289	2004
1.52	Ceramic gas nozzle; no. 5; Ø 8.0 mm; 48.0 mm long; (796F72)	10 Pcs.	701.0290	2004
1.52	Ceramic gas nozzle; no. 6; Ø 9.5 mm; 48.0 mm long; (796F73)	10 Pcs.	701.0291	2004
1.53	Ceramic gas nozzle; no. 4; Ø 6.5 mm; 63.0 mm long; (796F75)	10 Pcs.	701.0293	2004
1.53	Ceramic gas nozzle; no. 5; Ø 8.0 mm; 63.0 mm long; (796F76)	10 Pcs.	701.0294	2004
1.54	Ceramic gas nozzle; no. 4; Ø 6.5 mm; 89.0 mm long; (796F79)	10 Pcs.	701.0296	2004
1.61	Collet body for electrode with gas lens Ø 0.5 - 1.0 mm; (45V41 / 45V42)	10 Pcs.	701.0301	2016
1.61	Collet body for electrode with gas lens Ø 1.2 mm	10 Pcs.	701.0313	2016
1.61	Collet body for electrode with gas lens Ø 1.6 mm; (45V43)	10 Pcs.	701.0307	2016
1.61	Collet body for electrode with gas lens Ø 2.0 mm	10 Pcs.	701.0315	2016
1.61	Collet body for electrode with gas lens Ø 2.4 mm; (45V44)	10 Pcs.	701.0309	2016
1.61	Collet body for electrode with gas lens Ø 3.2 mm; (45V45)	10 Pcs.	701.0311	2016
1.62	Ceramic gas nozzle; no. 4; Ø 6.5 mm; 25.5 mm long; (53N58)	10 Pcs.	701.0317	2004
1.62	Ceramic gas nozzle; no. 5; Ø 8.0 mm; 25.5 mm long; (53N59)	10 Pcs.	701.0318	2004
1.62	Ceramic gas nozzle; no. 6; Ø 9.5 mm; 25.5 mm long; (53N60)	10 Pcs.	701.0319	2004
1.62	Ceramic gas nozzle; no. 7; Ø 11.0 mm; 25.5 mm long; (53N61)	10 Pcs.	701.0320	2004
1.71	Collet for electrode Ø 0.5 mm; 40.0 mm long; (13N20L)	10 Pcs.	701.1225	2007
1.71	Collet for electrode Ø 1.0 mm; 40.0 mm long; (13N21L)	10 Pcs.	701.1226	2007
1.71	Collet for electrode Ø 1.6 mm; 40.0 mm long; (13N22L)	10 Pcs.	701.1227	2007
1.71	Collet for electrode Ø 2.4 mm; 40.0 mm long; (13N23L)	10 Pcs.	701.1228	2007
1.71	Collet for electrode Ø 3.2 mm; 40.0 mm long; (13N24L)	10 Pcs.	701.1229	2007
1.72	Adaptor (54N63-20)	5 Pcs.	701.1234	2003
1.73	Collet body for electrode with gas lens Ø 0.5 - 1.0 mm; (45V0204S)	5 Pcs.	701.1230	2016
1.73	Collet body for electrode with gas lens Ø 1.6 mm; (45V116S)	5 Pcs.	701.1231	2016
1.73	Collet body for electrode with gas lens Ø 2.4 mm; (45V64S)	5 Pcs.	701.1232	2016
1.73	Collet body for electrode with gas lens Ø 3.2 mm; (995795S)	5 Pcs.	701.1233	2016
1.74	Ceramic gas nozzle; no. 6; Ø 9.5 mm; 48.0 mm long; (57N75)	10 Pcs.	701.1199	2004
1.74	Ceramic gas nozzle; no. 8; Ø 12.5 mm; 48.0 mm long; (57N74)	10 Pcs.	701.1200	2004
1.74	Ceramic gas nozzle; no. 10; Ø 16.0 mm; 48.0 mm long; (53N88)	10 Pcs.	701.1201	2004
1.74	Ceramic gas nozzle; no. 12; Ø 19.5 mm; 48.0 mm long; (53N87)	10 Pcs.	701.1121	2004
1.75	Ceramic gas nozzle; Ø 24.0 mm; 34.0 mm long; (53N89)	10 Pcs.	701.1202	2004

TIG Welding Torches ABITIG® GRIP 17 / 18 / 26 – ABITIG® GRIP Little 17

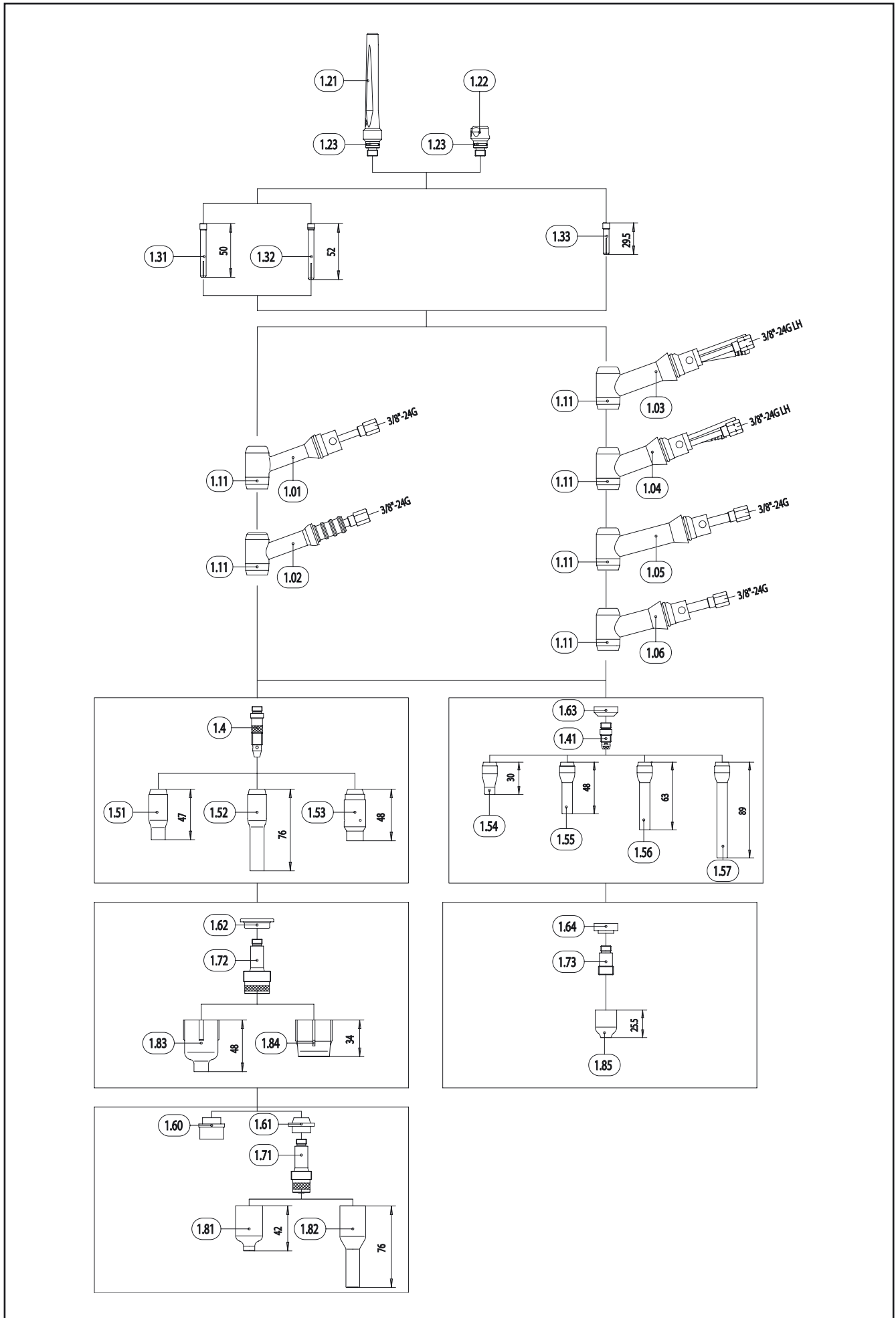

TIG Welding Torches ABITIG® GRIP 17 / 18 / 26 – ABITIG® GRIP Little 17

Pos.	Description	Units	Part-No.	Product-group
	Torch body			
1.01	Torch body ABITIG® GRIP 17; 65.0 mm long		712.1020	2002
w/o. fig.	Torch body ABITIG® GRIP 17 F (flexible); 65.0 mm long		712.1030	2002
1.02	Torch body SR / ABITIG® GRIP Little 17; 65.0 mm long		705.0033	2002
w/o. fig.	Torch body SR / ABITIG® GRIP Little 17 F (flexible); 60.0 mm long		703.0009	2002
1.03	Torch body ABITIG® GRIP 18; 69.0 mm long		712.2020	2002
w/o. fig.	Torch body ABITIG® GRIP 18 F (flexible); 69.0 mm long		712.2030	2002
1.04	Torch body ABITIG® GRIP 18 K (short); 59.0 mm long		712.2230	2002
1.05	Torch body ABITIG® GRIP 26; 79.0 mm long		712.4020	2002
w/o. fig.	Torch body ABITIG® GRIP 26 F (flexible); 79.0 mm long		712.4030	2002
1.06	Torch body ABITIG® GRIP 26 K (short); 59.0 mm long		712.4230	2002
1.11	Insulating ring	10 Pcs.	703.0012	2003
w/o. fig.	Shrink hose Ø 19.1 mm	60 m	104.0007	4050
	Wear parts			
1.21	Back cap, long	10 Pcs.	712.1051	2009
1.22	Back cap, short	10 Pcs.	712.1053	2009
1.23	O-Ring 10x1.5	20 Pcs.	165.0097	9010
1.31	Collet for electrode Ø 0.5 mm; 50.0 mm long; (10N21)	10 Pcs.	702.0005	2007
1.31	Collet for electrode Ø 1.0 mm; 50.0 mm long; (10N22)	10 Pcs.	702.0006	2007
1.31	Collet for electrode Ø 1.2 mm; 50.0 mm long	10 Pcs.	702.0007	2007
1.31	Collet for electrode Ø 1.6 mm; 50.0 mm long; (10N23)	10 Pcs.	702.0008	2007
1.31	Collet for electrode Ø 2.0 mm; 50.0 mm long	10 Pcs.	702.0012	2007
1.31	Collet for electrode Ø 2.4 mm; 50.0 mm long; (10N24)	10 Pcs.	702.0009	2007
1.31	Collet for electrode Ø 3.2 mm; 50.0 mm long; (10N25)	10 Pcs.	702.0010	2007
1.31	Collet for electrode Ø 4.0 mm; 50.0 mm long; (54N20)	10 Pcs.	702.0011	2007
1.32	Collet for electrode Ø 0.5 mm; 52.0 mm long; (10N21D)	10 Pcs.	701.0169	2007
1.32	Collet for electrode Ø 1.0 mm; 52.0 mm long; (10N22D)	10 Pcs.	701.0171	2007
1.32	Collet for electrode Ø 1.2 mm; 52.0 mm long	10 Pcs.	701.0170	2007
1.32	Collet for electrode Ø 1.6 mm; 52.0 mm long; (10N23D)	10 Pcs.	701.0172	2007
1.32	Collet for electrode Ø 2.0 mm; 52.0 mm long	10 Pcs.	701.0176	2007
1.32	Collet for electrode Ø 2.4 mm; 52.0 mm long; (10N24D)	10 Pcs.	701.0173	2007
1.32	Collet for electrode Ø 3.2 mm; 52.0 mm long; (10N25D)	10 Pcs.	701.0174	2007
1.32	Collet for electrode Ø 4.0 mm; 52.0 mm long; (54N20D)	10 Pcs.	701.0175	2007
1.33	Collet for electrode Ø 1.0 mm; 29.5 mm long; (10N22S)	10 Pcs.	701.1220	2007
1.33	Collet for electrode Ø 1.6 mm; 29.5 mm long; (10N23S)	10 Pcs.	701.1221	2007
1.33	Collet for electrode Ø 2.0 mm; 29.5 mm long	10 Pcs.	701.1222	2007
1.33	Collet for electrode Ø 2.4 mm; 29.5 mm long; (10N24S)	10 Pcs.	701.1223	2007
1.33	Collet for electrode Ø 3.2 mm; 29.5 mm long; (10N25S)	10 Pcs.	701.1224	2007
1.4	Collet body for electrode Ø 0.5 - 1.2 mm; (10N30)	10 Pcs.	701.0190	2008
1.4	Collet body for electrode Ø 1.6 mm; (10N31)	10 Pcs.	701.0191	2008
1.4	Collet body for electrode Ø 2.0 - 2.4 mm; (10N32)	10 Pcs.	701.0196	2008
1.4	Collet body for electrode Ø 3.2 mm; (10N28)	10 Pcs.	701.0197	2008
1.4	Collet body for electrode Ø 4.0 mm; (406488)	10 Pcs.	701.0198	2008
1.41	Collet body for electrode Ø 1.0 - 3.2 mm	10 Pcs.	701.1218	2008
1.51	Ceramic gas nozzle; no. 4; Ø 6.5 mm; 47.0 mm long; (10N50)	10 Pcs.	701.0107	2004
1.51	Ceramic gas nozzle; no. 5; Ø 8.0 mm; 47.0 mm long; (10N49)	10 Pcs.	701.0108	2004
1.51	Ceramic gas nozzle; no. 6; Ø 9.5 mm; 47.0 mm long; (10N48)	10 Pcs.	701.0109	2004
1.51	Ceramic gas nozzle; no. 7; Ø 11.0 mm; 47.0 mm long; (10N47)	10 Pcs.	701.0110	2004
1.51	Ceramic gas nozzle; no. 8; Ø 12.5 mm; 47.0 mm long; (10N46)	10 Pcs.	701.0111	2004
1.51	Ceramic gas nozzle; no. 10; Ø 16.0 mm; 47.0 mm long; (10N45)	10 Pcs.	701.0113	2004
w/o. fig.	Ceramic gas nozzle; no. 12; Ø 19.5 mm; 50.0 mm long; (10N44)	10 Pcs.	701.0114	2004
1.52	Ceramic gas nozzle; no. 5; Ø 8.0 mm; 76.0 mm long; (10N49L)	10 Pcs.	701.0115	2004
1.52	Ceramic gas nozzle; no. 6; Ø 9.5 mm; 76.0 mm long; (10N48L)	10 Pcs.	701.0116	2004
1.52	Ceramic gas nozzle; no. 7; Ø 11.0 mm; 76.0 mm long; (10N47L)	10 Pcs.	701.0117	2004
1.53	Ceramic gas nozzle; no. 5; Ø 8.0 mm; 48.0 mm long with metal shield; (10N55)		701.0124	2004
1.53	Ceramic gas nozzle; no. 6; Ø 9.5 mm; 48.0 mm long with metal shield; (10N54)		701.0126	2004

TIG Welding Torches ABITIG® GRIP 17 / 18 / 26 – ABITIG® GRIP Little 17

Pos.	Description	Units	Part-No.	Product-group
1.53	Ceramic gas nozzle; no. 7; Ø 11.0 mm; 48.0 mm long with metal shield; (10N53)		701.0118	2004
1.53	Ceramic gas nozzle; no. 8; Ø 12.5 mm; 48.0 mm long with metal shield; (10N52)		701.0120	2004
1.53	Ceramic gas nozzle; no. 10; Ø 16.0 mm; 48.0 mm long with metal shield; (10N51)		701.0122	2004
w/o. fig.	Ceramic spot weld nozzle; no. 8; Ø 12.5 mm; 55.0 mm long with metal shield (10N52P)		701.0129	2004
1.54	Ceramic gas nozzle; no. 4; Ø 6.5 mm; 30.0 mm long; (13N08)	10 Pcs.	701.0281	2004
1.54	Ceramic gas nozzle; no. 5; Ø 8.0 mm; 30.0 mm long; (13N09)	10 Pcs.	701.0282	2004
1.54	Ceramic gas nozzle; no. 6; Ø 9.5 mm; 30.0 mm long; (13N10)	10 Pcs.	701.0283	2004
1.54	Ceramic gas nozzle; no. 7; Ø 11.0 mm; 30.0 mm long; (13N11)	10 Pcs.	701.0284	2004
1.54	Ceramic gas nozzle; no. 8; Ø 12.5 mm; 30.0 mm long; (13N12)	10 Pcs.	701.0285	2004
1.54	Ceramic gas nozzle; no. 10; Ø 16.0 mm; 30.0 mm long; (13N13)	10 Pcs.	701.0286	2004
1.55	Ceramic gas nozzle; no. 4; Ø 6.5 mm; 48.0 mm long; (796F71)	10 Pcs.	701.0289	2004
1.55	Ceramic gas nozzle; no. 5; Ø 8.0 mm; 48.0 mm long; (796F72)	10 Pcs.	701.0290	2004
1.55	Ceramic gas nozzle; no. 6; Ø 9.5 mm; 48.0 mm long; (796F73)	10 Pcs.	701.0291	2004
1.56	Ceramic gas nozzle; no. 4; Ø 6.5 mm; 63.0 mm long; (796F75)	10 Pcs.	701.0293	2004
1.56	Ceramic gas nozzle; no. 5; Ø 8.0 mm; 63.0 mm long; (796F76)	10 Pcs.	701.0294	2004
1.57	Ceramic gas nozzle; no. 4; Ø 6.5 mm; 89.0 mm long; (796F79)	10 Pcs.	701.0296	2004
1.60	Insulator	10 Pcs.	701.0199	2003
1.61	Adaptor (54N01)	10 Pcs.	701.0130	2003
1.62	Adaptor (54N63)	5 Pcs.	701.1122	2003
1.63	Insulator (18CG20)	10 Pcs.	701.1219	2003
1.64	Insulator	10 Pcs.	701.1286	2003
1.71	Collet body for electrode with gas lens Ø 0.5 - 1.0 mm; (45V24)	10 Pcs.	701.0201	2016
1.71	Collet body for electrode with gas lens Ø 1.6 mm; (45V25)	10 Pcs.	701.0203	2016
1.71	Collet body for electrode with gas lens Ø 2.0 - 2.4 mm; (45V26)	10 Pcs.	701.0207	2016
1.71	Collet body for electrode with gas lens Ø 3.2 mm; (45V27)	10 Pcs.	701.0209	2016
1.71	Collet body for electrode with gas lens Ø 4.0 mm; (45V28)	10 Pcs.	701.0211	2016
1.72	Collet body for electrode with gas lens Ø 1.6 mm; (45V116)	5 Pcs.	701.1116	2016
1.72	Collet body for electrode with gas lens Ø 2.4 mm; (45V64)	5 Pcs.	701.1117	2016
1.72	Collet body for electrode with gas lens Ø 3.2 mm; (995795)	5 Pcs.	701.1118	2016
1.72	Collet body for electrode with gas lens Ø 4.0 mm; (45V63)	5 Pcs.	701.1208	2016
1.73	Collet body for electrode with gas lens Ø 1.0 mm	10 Pcs.	701.1287	2016
1.73	Collet body for electrode with gas lens Ø 1.6 mm	10 Pcs.	701.1288	2016
1.73	Collet body for electrode with gas lens Ø 2.4 mm	10 Pcs.	701.1289	2016
1.73	Collet body for electrode with gas lens Ø 3.2 mm	10 Pcs.	701.1290	2016
1.81	Ceramic gas nozzle; no. 4; Ø 6.5 mm; 42.0 mm long; (54N18)	10 Pcs.	701.0420	2004
1.81	Ceramic gas nozzle; no. 5; Ø 8.0 mm; 42.0 mm long; (54N17)	10 Pcs.	701.0421	2004
1.81	Ceramic gas nozzle; no. 6; Ø 9.5 mm; 42.0 mm long; (54N16)	10 Pcs.	701.0422	2004
1.81	Ceramic gas nozzle; no. 7; Ø 11.0 mm; 42.0 mm long; (54N15)	10 Pcs.	701.0423	2004
1.81	Ceramic gas nozzle; no. 8; Ø 12.5 mm; 42.0 mm long; (54N14)	10 Pcs.	701.0424	2004
1.81	Ceramic gas nozzle; no. 12; Ø 19.5 mm; 42.0 mm long; (54N19)	10 Pcs.	701.0426	2004
1.82	Ceramic gas nozzle; no. 5; Ø 8.0 mm; 76.0 mm long; (54N17L)	10 Pcs.	701.0427	2004
1.82	Ceramic gas nozzle; no. 6; Ø 9.5 mm; 76.0 mm long; (54N16L)	10 Pcs.	701.0428	2004
1.82	Ceramic gas nozzle; no. 7; Ø 11.0 mm; 76.0 mm long; (54N15L)	10 Pcs.	701.0429	2004
1.83	Ceramic gas nozzle; no. 6; Ø 9.5 mm; 48.0 mm long; (57N75)	10 Pcs.	701.1199	2004
1.83	Ceramic gas nozzle; no. 8; Ø 12.5 mm; 48.0 mm long; (57N74)	10 Pcs.	701.1200	2004
1.83	Ceramic gas nozzle; no.10; Ø 16.0 mm; 48,0 mm long (53N88)	10 Pcs.	701.1201	2004
1.83	Ceramic gas nozzle; no.12; Ø 19.5 mm; 48,0 mm long; (53N87)	10 Pcs.	701.1121	2004
1.84	Ceramic gas nozzle; Ø 24.0 mm; 34,0 mm long; (53N89)	10 Pcs.	701.1202	2004
1.85	Ceramic gas nozzle; no. 4; Ø 6.5 mm; 25.5 mm long; (53N58)	10 Pcs.	701.0317	2004
1.85	Ceramic gas nozzle; no. 5; Ø 8.0 mm; 25.5 mm long; (53N59)	10 Pcs.	701.0318	2004
1.85	Ceramic gas nozzle; no. 6; Ø 9.5 mm; 25.5 mm long; (53N60)	10 Pcs.	701.0319	2004
1.85	Ceramic gas nozzle; no. 7; Ø 11.0 mm; 25.5 mm long; (53N61)	10 Pcs.	701.0320	2004

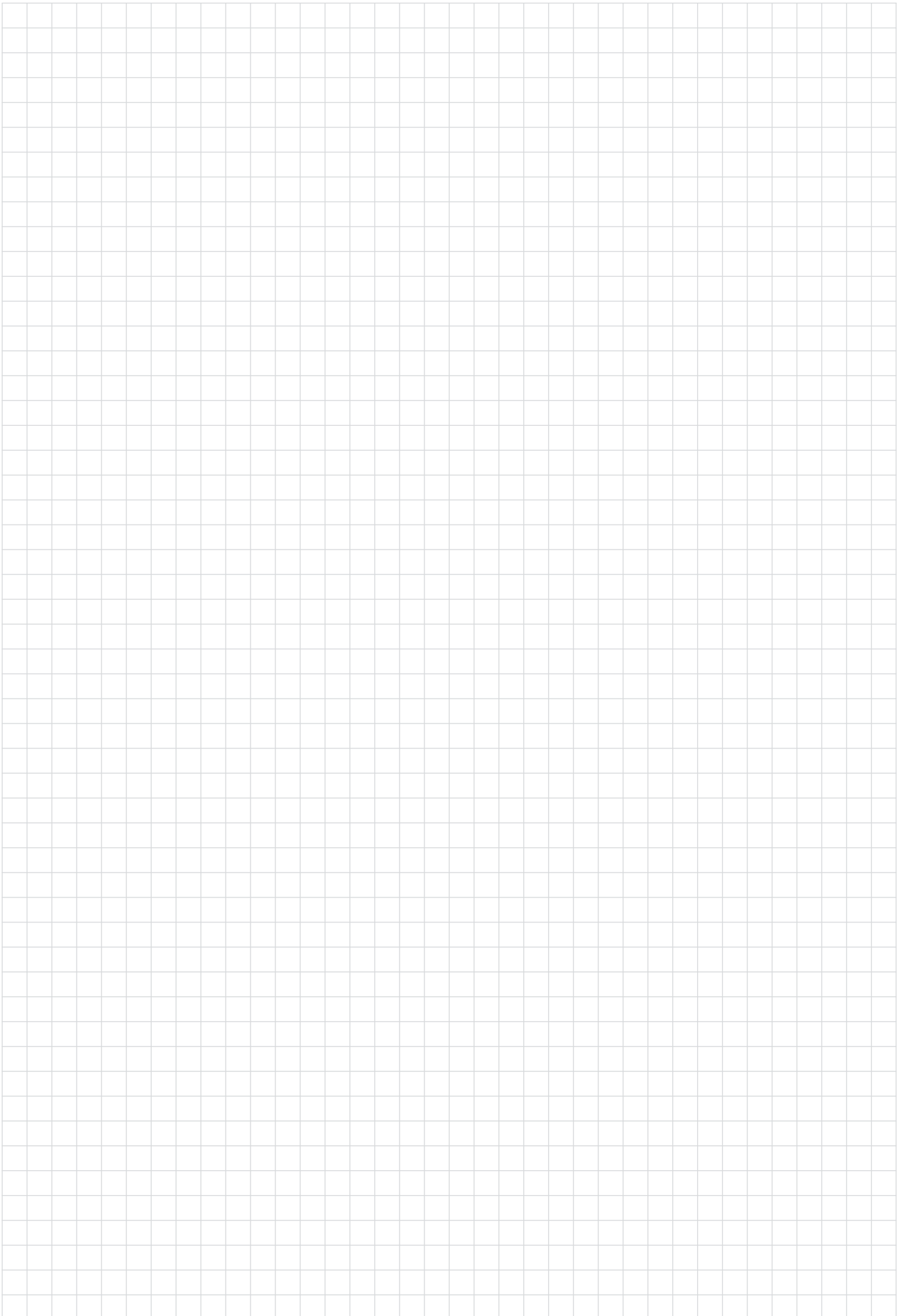

TIG Welding Torches ABITIG® GRIP 24 G / 24 W – ABITIG® GRIP Little 24 W

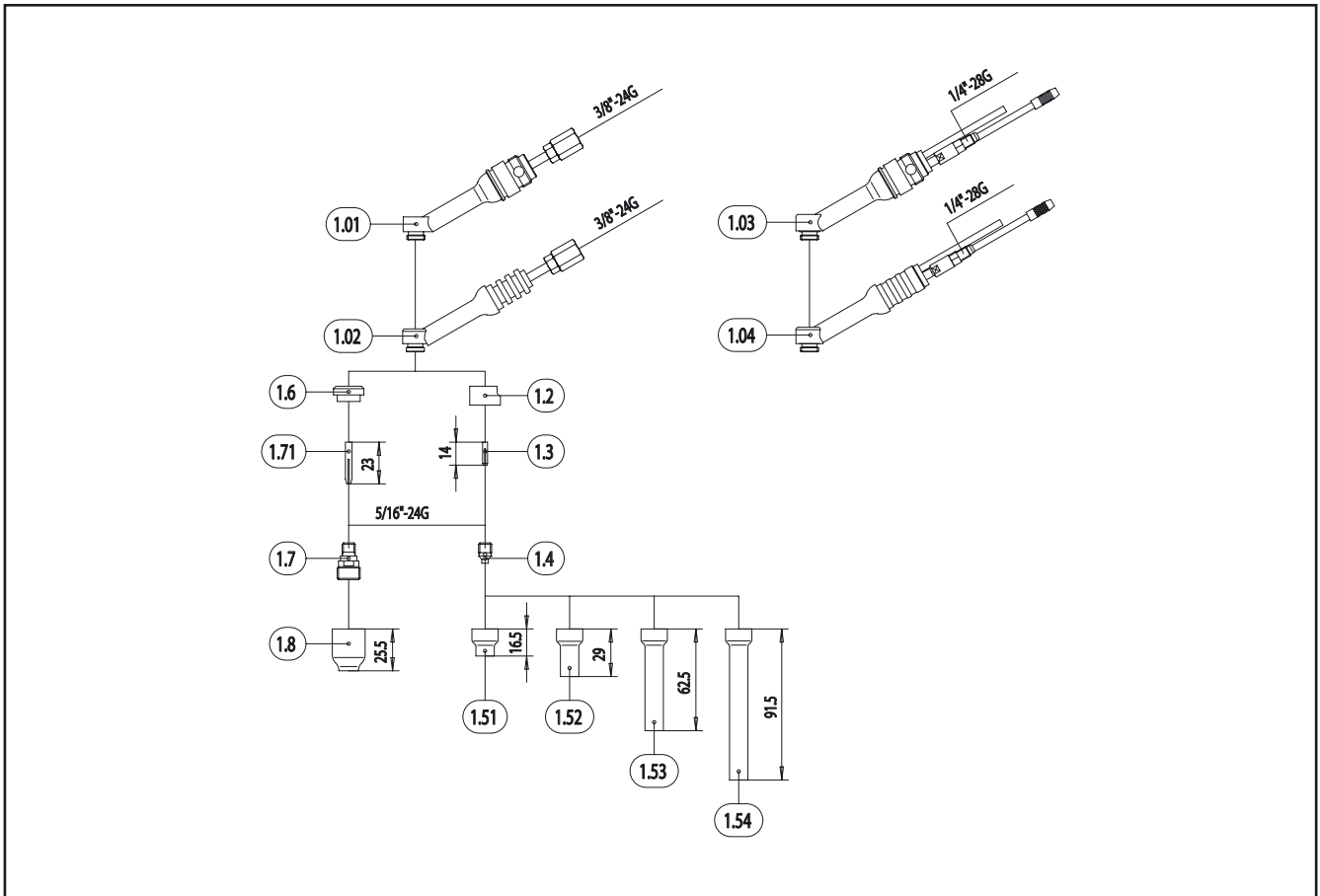

Pos.	Description	Units	Part-No.	Product-group
Torch body				
1.01	Torch body ABITIG® GRIP 24 G; 55,0 mm long		712.7020	2002
1.02	Torch body SR / ABITIG® GRIP Little 24 G; 55.0 mm long		705.0075	2002
1.03	Torch body ABITIG® GRIP 24 W; 55,0 mm long		712.7120	2002
1.04	Torch body SR / ABITIG® GRIP Little 24 W; 55.0 mm long		705.0080	2002
1.2	Insulator (53N22)	10 Pcs.	701.0458	2003
Wear parts				
1.3	Collet for electrode Ø 0.5 mm; 14.0 mm long; (53N15)	10 Pcs.	701.0452	2007
1.3	Collet for electrode Ø 1.0 mm; 14.0 mm long; (53N16)	10 Pcs.	701.0453	2007
1.3	Collet for electrode Ø 1.2 mm; 14.0 mm long	10 Pcs.	701.0455	2007
1.3	Collet for electrode Ø 1.6 mm; 14.0 mm long; (53N14)	10 Pcs.	701.0454	2007
1.3	Collet for electrode Ø 2.0 mm; 14.0 mm long	10 Pcs.	701.0456	2007
1.3	Collet for electrode Ø 2.4 mm; 14.0 mm long; (24C332)	10 Pcs.	701.0457	2007
1.4	Collet body for electrode Ø 0.5 mm; (53N17)	10 Pcs.	701.0479	2008
1.4	Collet body for electrode Ø 1.0 mm; (53N18)	10 Pcs.	701.0480	2008
1.4	Collet body for electrode Ø 1.2 mm	10 Pcs.	701.0483	2008
1.4	Collet body for electrode Ø 1.6 mm; (53N19)	10 Pcs.	701.0481	2008
1.4	Collet body for electrode Ø 2.0 mm	10 Pcs.	701.0484	2008
1.4	Collet body for electrode Ø 2.4 mm; (24CB332)	10 Pcs.	701.0482	2008
1.51	Ceramic gas nozzle; no. 4; Ø 6.5 mm; 16.5 mm long; (53N24)	10 Pcs.	701.0468	2004
1.51	Ceramic gas nozzle; no. 5; Ø 8.0 mm; 16.5 mm long; (53N25)	10 Pcs.	701.0469	2004
1.51	Ceramic gas nozzle; no. 6; Ø 9.5 mm; 16.5 mm long; (53N27)	10 Pcs.	701.0470	2004
1.52	Ceramic gas nozzle; no. 4; Ø 6.5 mm; 29.0 mm long; (53N28)	10 Pcs.	701.0471	2004
1.52	Ceramic gas nozzle; no. 6; Ø 9.5 mm; 29.0 mm long; (53N26)	10 Pcs.	701.0472	2004
1.53	Ceramic gas nozzle; no. 4L; Ø 6.5 mm; 62.5 mm long; (53N24L)	10 Pcs.	701.0473	2004
1.54	Ceramic gas nozzle; no. 5L; Ø 8.0 mm; 91.5 mm long; (53N27L)	10 Pcs.	701.0474	2004
1.6	Insulator (53N66)	10 Pcs.	701.0459	2003
1.7	Collet for electrode Ø 0.5 mm; 23.0 mm long	10 Pcs.	701.0461	2007

TIG Welding Torch ABITIG® GRIP 12-1

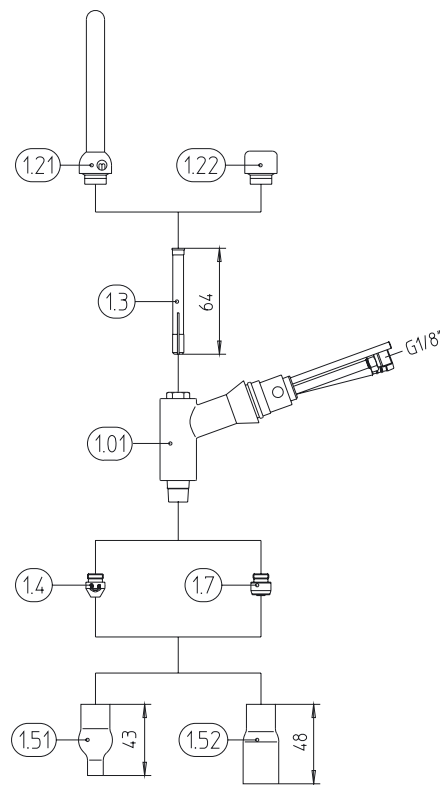

Pos.	Description	Units	Part-No.	Product-group
	Torch body			
1.01	Torch body ABITIG® GRIP 12-1; 70.0 mm long		712.0020	2002
w/o. fig.	Shrink hose Ø 19.1 mm	60 m	104.0007	4050
	Wear parts			
1.21	Back cap, long		712.0051	2009
1.22	Back cap, short		712.0053	2009
1.3	Collet for electrode Ø 1.6 mm; 64.0 mm long	10 Pcs.	712.0062	2007
1.3	Collet for electrode Ø 2.4 mm; 64.0 mm long	10 Pcs.	712.0063	2007
1.3	Collet for electrode Ø 3.2 mm; 64.0 mm long	10 Pcs.	712.0064	2007
1.3	Collet for electrode Ø 4.0 mm; 64.0 mm long	10 Pcs.	712.0065	2007
1.4	Collet body for electrode Ø 1.6 mm	10 Pcs.	712.0072	2008
1.4	Collet body for electrode Ø 2.4 mm	10 Pcs.	712.0073	2008
1.4	Collet body for electrode Ø 3.2 mm	10 Pcs.	712.0074	2008
1.4	Collet body for electrode Ø 4.0 mm	10 Pcs.	712.0075	2008
1.51	Ceramic gas nozzle; no. 4; Ø 6.5 mm; 43.0 mm long	10 Pcs.	704.0046	2004
1.51	Ceramic gas nozzle; no. 5; Ø 8.0 mm; 43.0 mm long	10 Pcs.	704.0047	2004
1.51	Ceramic gas nozzle; no. 6; Ø 9.5 mm; 43.0 mm long	10 Pcs.	704.0048	2004
1.51	Ceramic gas nozzle; no. 7; Ø 11.0 mm; 43.0 mm long	10 Pcs.	704.0049	2004
1.51	Ceramic gas nozzle; no. 8; Ø 12.5 mm; 43.0 mm long	10 Pcs.	704.0050	2004
1.51	Ceramic gas nozzle; no. 9; Ø 14.5 mm; 43.0 mm long	10 Pcs.	704.0051	2004
1.51	Ceramic gas nozzle; no. 10; Ø 16.0 mm; 48.0 mm long	10 Pcs.	704.0052	2004
1.52	Ceramic gas nozzle; no. 11; Ø 17.5 mm	10 Pcs.	704.0053	2004
1.7	Collet body for electrode with gas lens Ø 1.6 mm		712.0101	2016
1.7	Collet body for electrode with gas lens Ø 2.4 mm		712.0102	2016
1.7	Collet body for electrode with gas lens Ø 3.2 mm		712.0103	2016
1.7	Collet body for electrode with gas lens Ø 4.0 mm		712.0104	2016

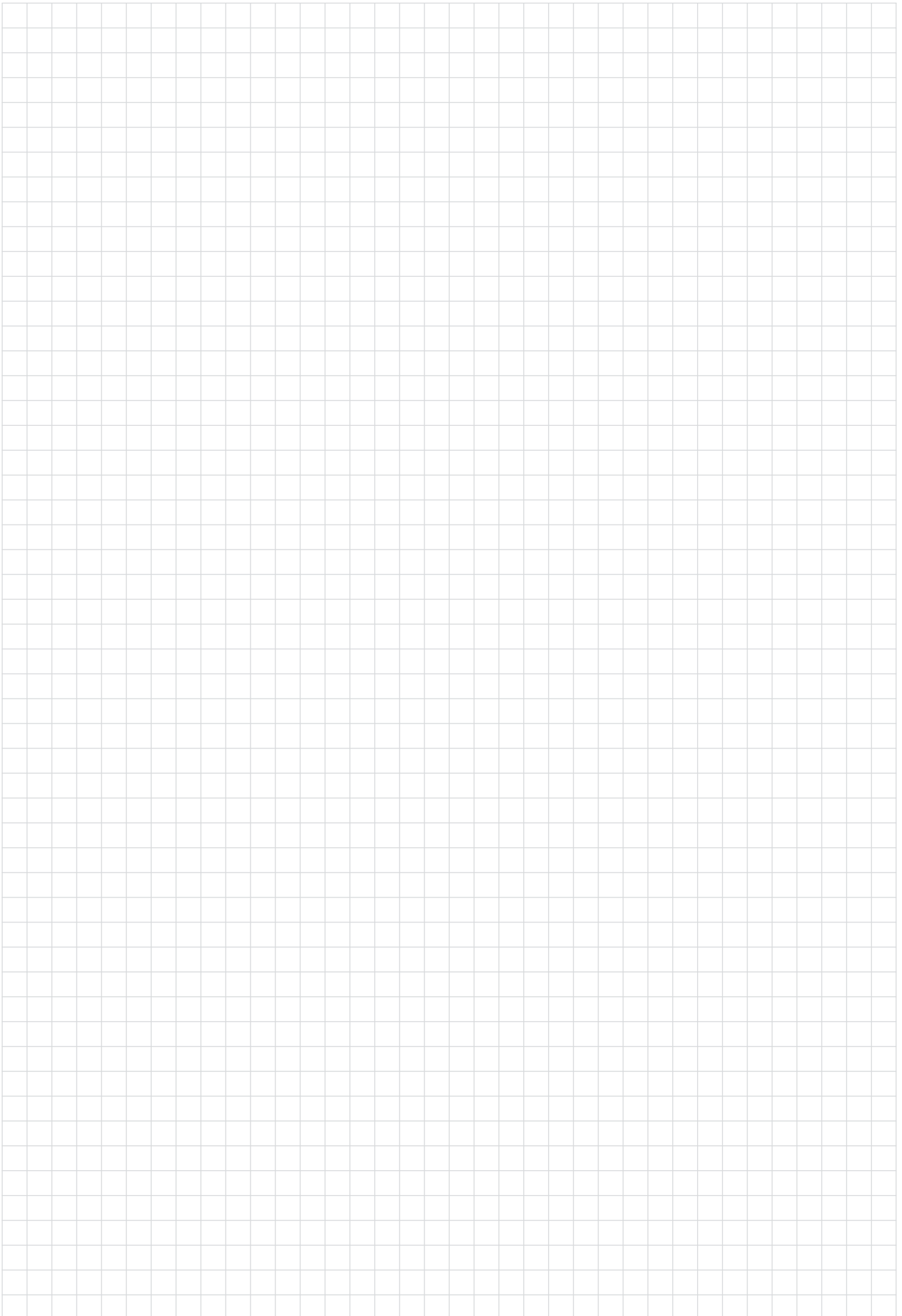

TIG Welding Torch ABITIG® GRIP 18 SC

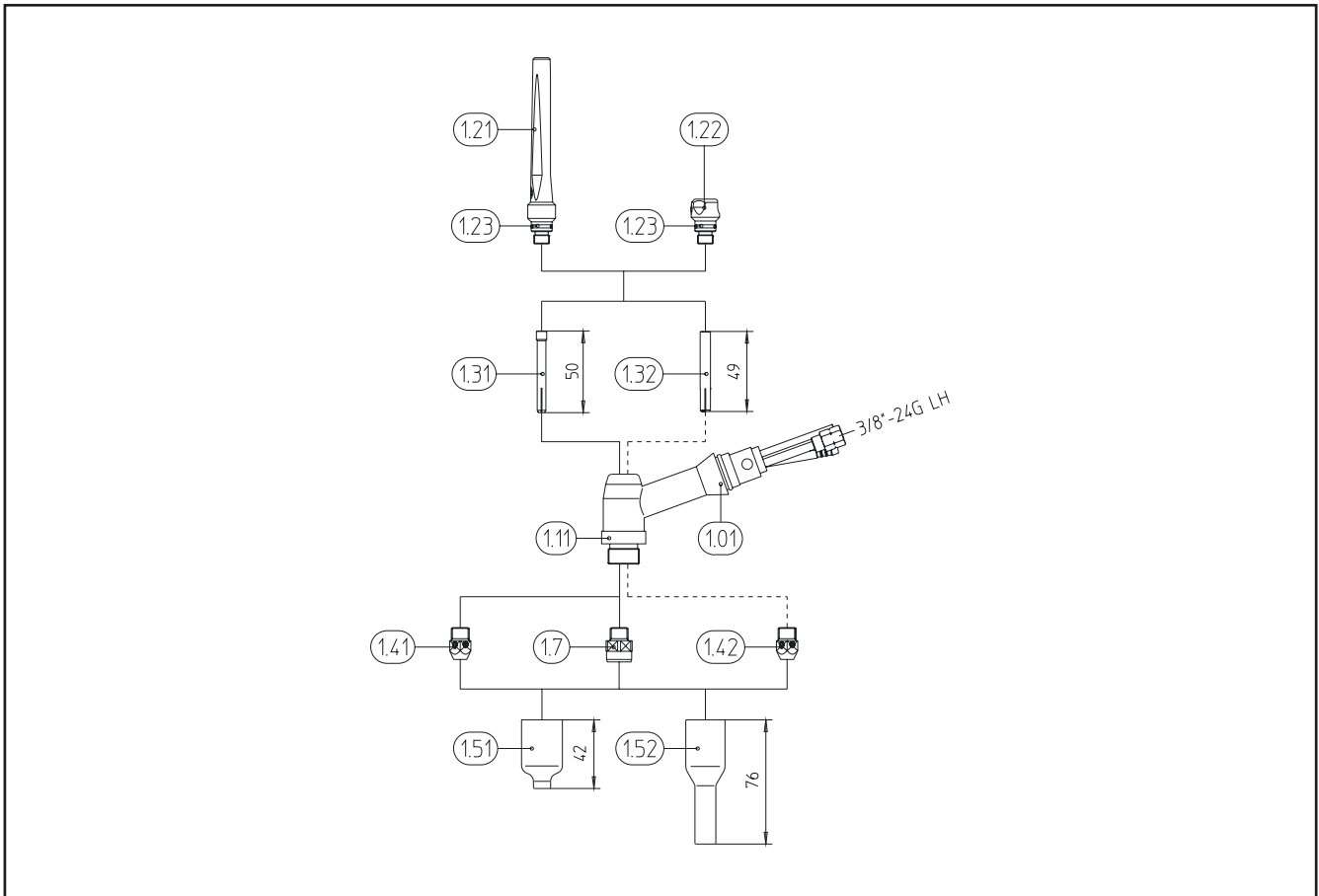

Pos.	Description	Units	Part-No.	Product-group
	Torch body			
1.01	Torch body ABITIG® GRIP 18 SC; 75.0 mm long		712.6020	2002
w/o. fig.	Shrink hose Ø 19.1 mm	60 m	104.0007	4050
1.11	Insulating ring	5 Pcs.	712.6043	2003
	Wear parts			
1.21	Back cap, long	10 Pcs.	712.1051	2009
1.22	Back cap, short	10 Pcs.	712.1053	2009
1.23	O-Ring 10x1.5	20 Pcs.	165.0097	9010
1.31	Collet for electrode Ø 0.5 mm; 50,0 mm long; (10N21)	10 Pcs.	702.0005	2007
1.31	Collet for electrode Ø 1.0 mm; 50,0 mm long; (10N22)	10 Pcs.	702.0006	2007
1.31	Collet for electrode Ø 1.6 mm; 50,0 mm long; (10N23)	10 Pcs.	702.0008	2007
1.31	Collet for electrode Ø 2.4 mm; 50,0 mm long; (10N24)	10 Pcs.	702.0009	2007
1.31	Collet for electrode Ø 3.2 mm; 50,0 mm long; (10N25)	10 Pcs.	702.0010	2007
1.32	Collet for electrode HL Ø 3.2 mm; 49,0 mm long; (10N25HD)	10 Pcs.	712.6064	2007
1.32	Collet for electrode HL Ø 4.0 mm; 49,0 mm long; (54N20HD)	10 Pcs.	712.6065	2007
1.32	Collet for electrode HL Ø 4.8 mm; 49,0 mm long; (18C36)	10 Pcs.	712.6066	2007
1.41	Collet body for electrode Ø 0.5 - 3.2 mm; (NCB-53)		712.6074	2008
1.42	Collet body for electrode HL Ø 3.2 - 4.8 mm; (NCB-36)		712.6076	2008
1.51	Ceramic gas nozzle; no. 4; Ø 6.5 mm; 42,0 mm long; (54N18)	10 Pcs.	701.0420	2004
1.51	Ceramic gas nozzle; no. 5; Ø 8.0 mm; 42,0 mm long; (54N17)	10 Pcs.	701.0421	2004
1.51	Ceramic gas nozzle; no. 6; Ø 9.5 mm; 42,0 mm long; (54N16)	10 Pcs.	701.0422	2004
1.51	Ceramic gas nozzle; no. 7; Ø 11.0 mm; 42,0 mm long; (54N15)	10 Pcs.	701.0423	2004
1.51	Ceramic gas nozzle; no. 8; Ø 12.5 mm; 42,0 mm long; (54N14)	10 Pcs.	701.0424	2004
1.51	Ceramic gas nozzle; no. 12; Ø 19.5 mm; 42,0 mm long; (54N19)	10 Pcs.	701.0426	2004
1.52	Ceramic gas nozzle; no. 5; Ø 8.0 mm; 76,0 mm long; (54N17L)	10 Pcs.	701.0427	2004
1.52	Ceramic gas nozzle; no. 6; Ø 9.5 mm; 76,0 mm long; (54N16L)	10 Pcs.	701.0428	2004
1.52	Ceramic gas nozzle; no. 7; Ø 11.0 mm; 76,0 mm long; (54N15L)	10 Pcs.	701.0429	2004
1.7	Collet body for electrode with gas lens Ø 0.5 mm; (18GL02)		712.6099	2016

Notes

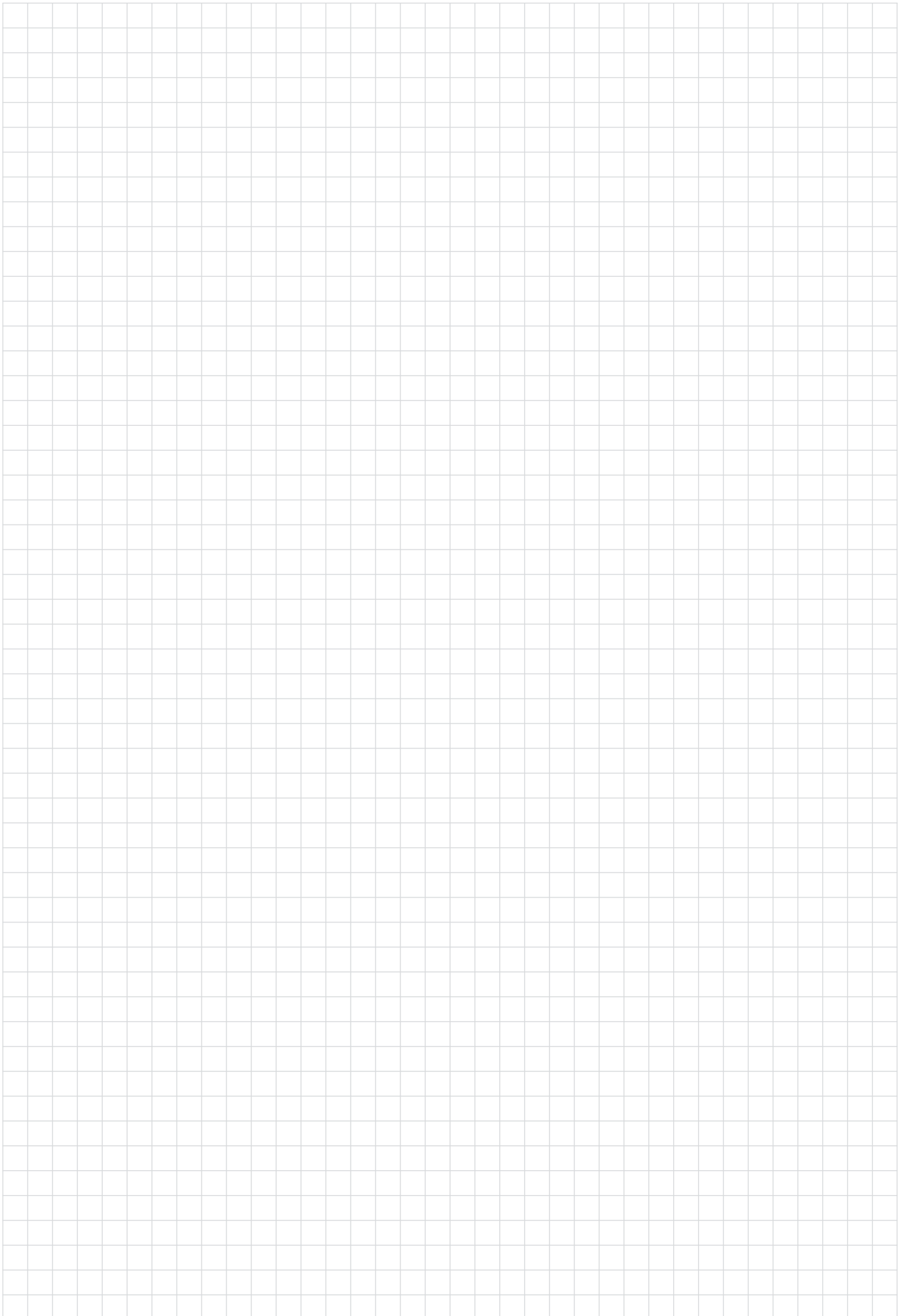



TIG Welding Torches

ABITIG® GRIP

air and liquid cooled

“For highest operational performance”

The ABITIG® GRIP line “ABICOR BINZEL-Style”, air and liquid cooled, offer leading edge performance in a comfortable and light weight package. The cooling system guarantees long service life and enables the use of smaller tungsten electrodes through optimised heat dissipation.

The reduction in the quantity of consumables to only three components (back cap, electrode holder / gas diffuser and threaded gas nozzle) simplifies use and helps reduce stocking costs. The innovative torch design prevents the heat from the gas nozzle reaching the torch body. This protects the torch, increases service life and further reduces operating costs.

The intelligent ABITIG® GRIP handle offers increased comfort due to the integration of numerous switching and control functions. Furthermore it is well protected against high frequency (HF) flashover.

- One ergonomic handle with “GRIP” for all ABITIG® GRIP torch types – offers high gripability and optimum feel
- Modular switching and control functions integrated into the handle – individually and ergonomically
- Short ball joint for optimum movement radius and ideal handling
- Light and flexible cable assemblies with modular machine-side connections for all available TIG welding power sources
- Reduced storage costs with only three consumable parts



Technical data
(EN 60 974-7)

TIG Welding Torches “ABITIG® GRIP” (air cooled)

Type	Rating (A)		Duty cycle (%)	Tungsten electrode-Ø (mm)
	DC	AC		
ABITIG® GRIP 150 / F	150	105	35	1.0 - 2.4
ABITIG® GRIP 200 / F / K	200	140	35	1.6 - 3.2

F=Flexible. K=Short. Subject to change without notice.

TIG Welding Torches “ABITIG® GRIP” (liquid cooled)

Type	Rating (A)		Duty cycle (%)	Tungsten electrode-Ø (mm)
	DC	AC		
ABITIG® GRIP 260 W	260	185	100	1.0 - 3.2
ABITIG® GRIP 450 W / K	400	280	100	1.6 - 4.8
ABITIG® GRIP 450 W SC	450	320	100	1.6 - 4.8

K=Short. Subject to change without notice.



TIG Welding Torches

ABITIG® GRIP Little

air and liquid cooled

“Maximum flexibility with no compromises”

The welding torch line ABITIG® GRIP Little – particularly suited to those everyday, less accessible welding jobs. Maximum flexibility with no compromises.

The torches of various ratings, both air and liquid cooled, are combined with a standardized ergonomic handle with “GRIP” and optimised cable assembly management, into which standard switching and control functions can be integrated.

In addition the flexible cable assemblies are available with modular and robust machine-side connections.

- One ergonomic handle with “GRIP” for all ABITIG® GRIP torch types – offers high gripability and optimum feel
- Modular switching and control functions integrated into the handle
- Excellent protection against high frequency flashover
- Light and flexible cable assemblies (High-Flex-Leather) with modular machine-side connections for all available TIG welding power sources
- Air cooled up to 140 A – at 35% duty cycle
- Liquid cooled up to 240 A – at 100% duty cycle

Technical data (EN 60 974-7)

TIG Welding Torches “ABITIG® GRIP Little” (air cooled)

Type	Rating (A)		Duty cycle (%)	Tungsten electrode-Ø (mm)
	DC	AC		
ABITIG® GRIP Little 150 / F	110	80	35	0.5 - 1.6

F=Flexible. Subject to change without notice.

TIG Welding Torches “ABITIG® GRIP Little” (liquid cooled)

Type	Rating (A)		Duty cycle (%)	Tungsten electrode-Ø (mm)
	DC	AC		
ABITIG® GRIP Little 260 W	220	150	100	0.5 - 3.2

Subject to change without notice.

TIG Welding Torches ABITIG® GRIP 150 / 260 W – ABITIG® GRIP Little 150 / 260 W

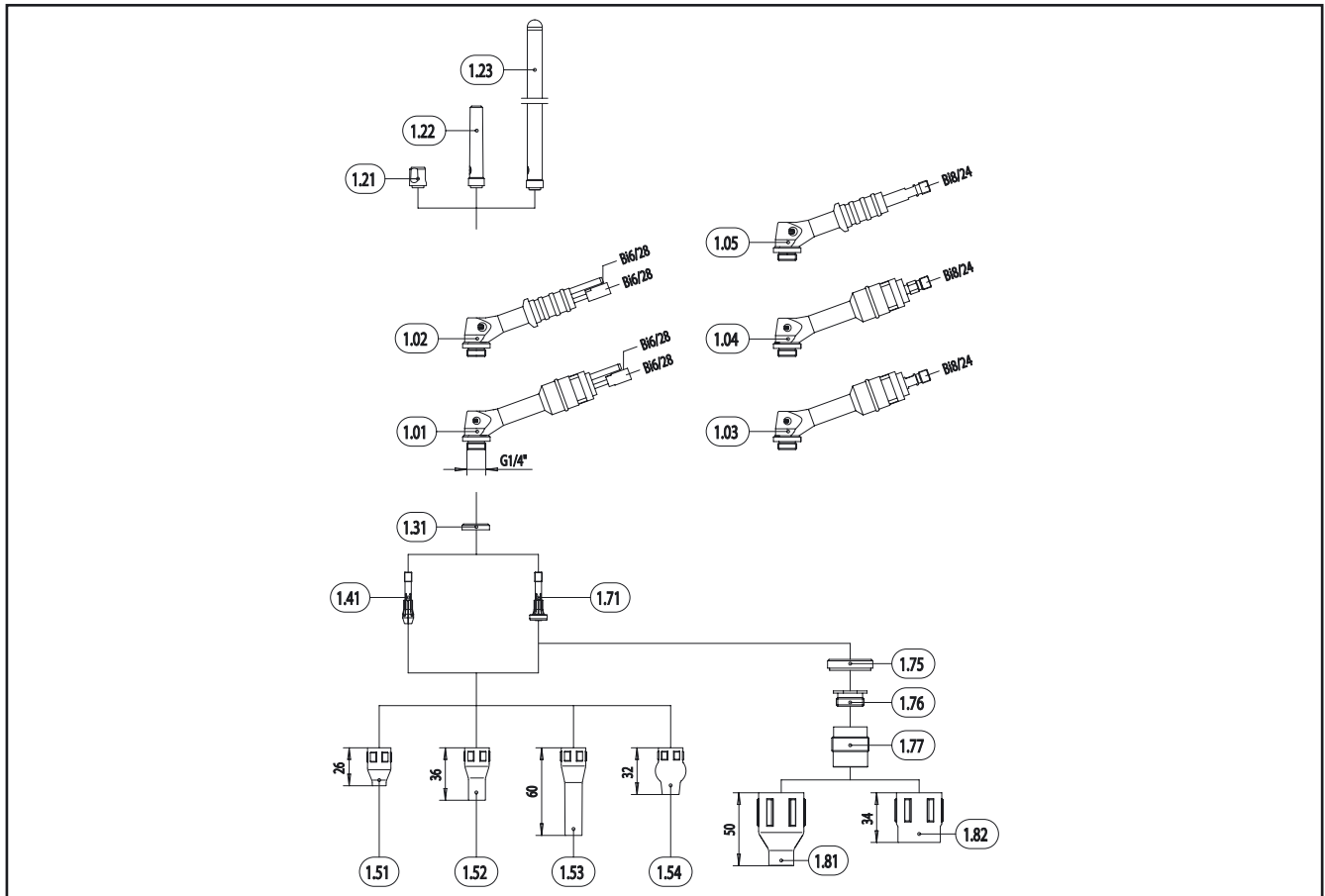

Pos.	Description	Units	Part-No.	Product-group
Torch body				
1.01	Torch body ABITIG® GRIP 260 W; 60.0 mm long		777.0010	2522
1.02	Torch body ABITIG® GRIP Little 260 W; 46.0 mm long		772.0010.1	2522
1.03	Torch body ABITIG® GRIP 150; 60.0 mm long		776.0010	2522
1.04	Torch body ABITIG® GRIP 150 F (flexible); 60.0 mm long		776.0130	2522
1.05	Torch body ABITIG® GRIP Little 150; 46.0 mm long		770.0010.1	2522
w/o. fig.	Torch body ABITIG® GRIP 150 Little (flexible); 46.0 mm long		770.0130.1	2522
Wear parts				
1.21	Back cap, short		776.0053	2545
1.22	Back cap, medium		771.0051	2545
1.23	Back cap, long		776.0051	2545
1.31	Insulator	10 Pcs.	776.1043	2555
1.41	Electrode holder for electrode WE Ø 1.0 mm	5 Pcs.	776.0061	2548
1.41	Electrode holder for electrode WE Ø 1.6 mm	5 Pcs.	776.0062	2548
1.41	Electrode holder for electrode WE Ø 2.0 mm	5 Pcs.	776.0067	2548
1.41	Electrode holder for electrode WE Ø 2.4 mm	5 Pcs.	776.0063	2548
1.41	Electrode holder for electrode WE Ø 3.2 mm	5 Pcs.	776.0064	2548
1.51	Ceramic gas nozzle 26 mm; ND 6.5 mm	10 Pcs.	777.0081	2541
1.51	Ceramic gas nozzle 26 mm; ND 8.0 mm	10 Pcs.	777.0082	2541
1.51	Ceramic gas nozzle 26 mm; ND 9.5 mm	10 Pcs.	777.0083	2541
1.51	Ceramic gas nozzle 26 mm; ND 11.0 mm	10 Pcs.	777.0084	2541
1.52	Ceramic gas nozzle 36 mm; ND 6.5 mm	10 Pcs.	777.2171	2541
1.52	Ceramic gas nozzle 36 mm; ND 8.0 mm	10 Pcs.	777.2172	2541
1.52	Ceramic gas nozzle 36 mm; ND 9.5 mm	10 Pcs.	777.2173	2541
1.52	Ceramic gas nozzle 36 mm; ND 11.0 mm	10 Pcs.	777.2174	2541
1.53	Ceramic gas nozzle 60 mm; ND 6.5 mm	10 Pcs.	777.2175	2541
1.53	Ceramic gas nozzle 60 mm; ND 8.0 mm	10 Pcs.	777.2176	2541
1.54	Ceramic gas nozzle 32 mm; ND 6.5 mm	10 Pcs.	770.0081.10	2541

TIG Welding Torches ABITIG® GRIP 200 / 450 W / 450 W SC

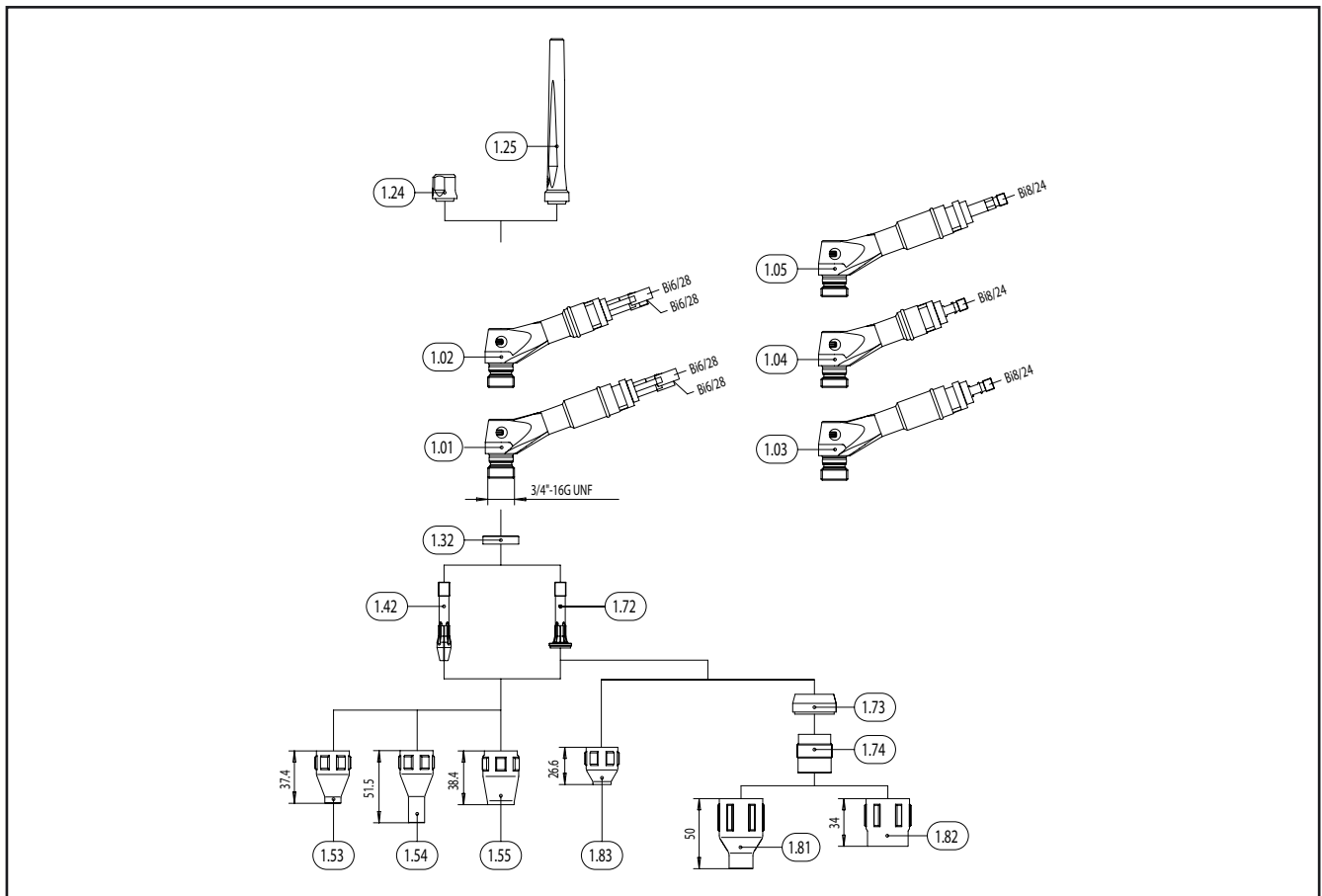

Pos.	Description	Units	Part-No.	Product-group
Torch body				
1.01	Torch body ABITIG® GRIP 450 W; 80.0 mm long		775.0010	2522
1.02	Torch body ABITIG® GRIP 450 W K (short); 60.0 mm long		775.0230	2522
1.03	Torch body ABITIG® GRIP 200; 80.0 mm long		774.0010	2522
1.04	Torch body ABITIG® GRIP 200 K (short); 60.0 mm long		774.0230	2522
1.05	Torch body ABITIG® GRIP 200 F (flexible); 80.0 mm long		774.0130	2522
Wear parts				
1.24	Back cap, short		773.0053	2545
1.25	Back cap, long		773.0051	2545
1.32	Insulator		775.1043	2555
1.42	Electrode holder for electrode WE Ø 1.6 mm	5 Pcs.	775.0062	2548
1.42	Electrode holder for electrode WE Ø 2.0 mm	5 Pcs.	775.0067	2548
1.42	Electrode holder for electrode WE Ø 2.4 mm	5 Pcs.	775.0063	2548
1.42	Electrode holder for electrode WE Ø 3.2 mm	5 Pcs.	775.0064	2548
1.42	Electrode holder for electrode WE Ø 4.0 mm	5 Pcs.	775.0065	2548
1.42	Electrode holder for electrode WE Ø 4.8 mm	5 Pcs.	775.0066	2548
1.53	Ceramic gas nozzle 37.4 mm; ND 7.5 mm	10 Pcs.	775.0081	2541
1.53	Ceramic gas nozzle 37.4 mm; ND 10.5 mm	10 Pcs.	775.0082	2541
1.53	Ceramic gas nozzle 37.4 mm; ND 13.0 mm	10 Pcs.	775.0083	2541
1.53	Ceramic gas nozzle 37.4 mm; ND 15.0 mm	10 Pcs.	775.0084	2541
1.54	Ceramic gas nozzle 51.5 mm; ND 7.5 mm	10 Pcs.	775.2171	2541
1.54	Ceramic gas nozzle 51.5 mm; ND 10.0 mm	10 Pcs.	775.2172	2541
1.54	Ceramic gas nozzle 51.5 mm; ND 13.0 mm	10 Pcs.	775.2173	2541
1.54	Ceramic gas nozzle 51.5 mm; ND 16.0 mm	10 Pcs.	775.2174	2541
1.55	Ceramic gas nozzle 38.4 mm; ND 15.0 mm (reinforced)	10 Pcs.	775.0184	2541
1.55	Ceramic gas nozzle 38.4 mm; ND 13.0 mm (reinforced)	10 Pcs.	775.0183	2541
1.72	Gas diffuser for electrode WE-Ø 1.6 mm		773.0172	2548
1.72	Gas diffuser for electrode WE-Ø 2.0 mm		773.0177	2548

Notes

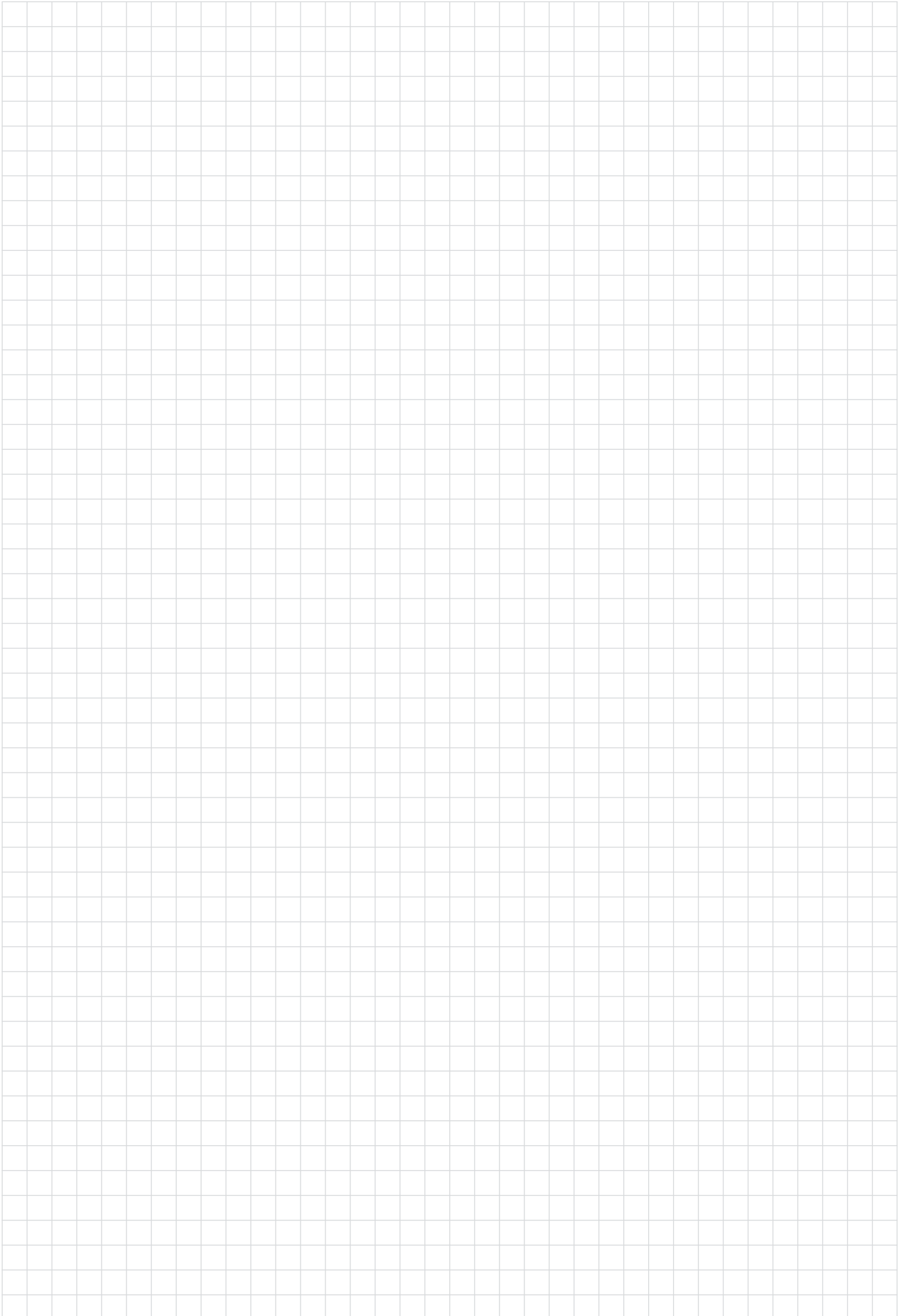



Component kits

ABITIG® GRIP and ABITIG® GRIP Little

- **Component kit "Standard" for
ABITIG® GRIP 9 / 17 / 18 / 18 SC / 20 / 26 and 12-1
ABITIG® GRIP Little 9 / 17 and 20**
consisting of: Back cap long, collet, collet body and
gas nozzle ceramic
- **Component kit "Gas lens" for
ABITIG® GRIP 9 / 17 / 18 / 18 SC / 20 / 26 and 12-1
ABITIG® GRIP Little 9 / 17 and 20**
consisting of: Back cap long, collet, collet body with gas lens
and gas nozzle ceramic
- **Component kit "Electrode holder" for
ABITIG® GRIP 150 and 260 W
ABITIG® GRIP Little 150 and 260 W**
consisting of: Back cap middle, electrode holder and
gas nozzle ceramic
- **Component kit "Gas diffuser" for
ABITIG® GRIP 150 and 260 W
ABITIG® GRIP Little 150 and 260 W**
consisting of: Back cap middle, gas diffuser and
gas nozzle ceramic
- **Component kit "Electrode holder" for
ABITIG® GRIP 200, 450 W and 450 W SC**
consisting of: Back cap long, electrode holder and
gas nozzle ceramic
- **Component kit "Gas diffuser" for
ABITIG® GRIP 200, 450 W and 450 W SC**
consisting of: Back cap long, gas diffuser and
gas nozzle ceramic

Component kits

Pos.	Description	Units	Part-No.	Product-group
	Component kit ABITIG® 9 / 20			
w/o. fig.	Component kit for electrode WE-Ø 1.6		712.3151	2005
	Component kit gas lens ABITIG® 9 / 20			
w/o. fig.	Component kit for electrode gas lens WE-Ø 1.6		712.3191	2005
	Component kit ABITIG® 17 / 18 / 26			
w/o. fig.	Component kit for electrode WE-Ø 1.6		712.2151	2005
w/o. fig.	Component kit for electrode WE-Ø 2.4		712.2152	2005
w/o. fig.	Component kit for electrode WE-Ø 3.2		712.2153	2005
	Component kit gas lens ABITIG® 17 / 18 / 26			
w/o. fig.	Component kit for electrode gas lens WE-Ø 1.6		712.2191	2005
w/o. fig.	Component kit for electrode gas lens WE-Ø 2.4		712.2192	2005
w/o. fig.	Component kit for electrode gas lens WE-Ø 3.2		712.2193	2005
	Component kit ABITIG® 12-1			
w/o. fig.	Component kit for electrode WE-Ø 2.4		712.0152	2005
w/o. fig.	Component kit for electrode WE-Ø 3.2		712.0153	2005
	Component kit gas lens ABITIG® 12-1			
w/o. fig.	Component kit for electrode gas lens WE-Ø 2.4		712.0192	2005
w/o. fig.	Component kit for electrode gas lens WE-Ø 2.4		712.0192	2005
	Component kit ABITIG® 18 SC			
w/o. fig.	Component kit for electrode WE-Ø 2.4		712.6152	2005
w/o. fig.	Component kit for electrode HL WE-Ø 3.2		712.6153	2005
	Component kit gas lens ABITIG® 18 SC			
w/o. fig.	Component kit for electrode gas lens WE-Ø 2.4		712.6192	2005
w/o. fig.	Component kit for electrode HL gas lens WE-Ø 3.2		712.6193	2005
	Component kit ABITIG® 24 G / 24 W			
w/o. fig.	Component kit for electrode WE-Ø 1.6		705.1519	2005
w/o. fig.	Component kit for electrode WE-Ø 2.4		705.1520	2005
	Component kit ABITIG® 150 / 260 W			
w/o. fig.	Component kit standard for electrode WE-Ø 1.6		777.0182	2550
w/o. fig.	Component kit standard for electrode WE-Ø 2.4		777.0183	2550
w/o. fig.	Component kit standard for electrode WE-Ø 3.2		777.0184	2550
	Component kit gas diffuser ABITIG® 150 / 260 W			
w/o. fig.	Component kit gas diffuser for electrode WE-Ø 1.6		777.0192	2550
w/o. fig.	Component kit gas diffuser for electrode WE-Ø 2.4		777.0193	2550
w/o. fig.	Component kit gas diffuser for electrode WE-Ø 3.2		777.0194	2550
	Component kit ABITIG® 200 / 450 W / 450 W SC			
w/o. fig.	Component kit standard for electrode WE-Ø 2.4		774.0183	2550
w/o. fig.	Component kit standard for electrode WE-Ø 3.2		774.0184	2550
w/o. fig.	Component kit standard for electrode WE-Ø 4.8		774.0186	2550
	Component kit gas diffuser ABITIG® 200 / 450 W / 450 W SC			
w/o. fig.	Component kit gas diffuser for electrode WE-Ø 2.4		774.0193	2550
w/o. fig.	Component kit gas diffuser for electrode WE-Ø 3.2		774.0194	2550
w/o. fig.	Component kit gas diffuser for electrode WE-Ø 4.8		774.0196	2550



Handles and control modules **BIS** "ABITIG® GRIP and ABITIG® GRIP Little – the intelligent handle system for increased comfort"

- Light weight, rugged material and construction
- Optionally with different control elements for nearly all TIG Welding power sources
- Enclosed switching elements for high electrical and mechanical duty
- Excellent high frequency protection
- Applicable for right and left handers
- Short ball joint for optimum movement radius and ideal handling



Handles and control modules

1 Handle ABITIG® GRIP Little

- 1.1  **BIS-51**
ED = Single push-button
- 1.2  **BIS-52**
DD = Double push-button / Button short
(Standard under DD)
- 1.3  **BIS-65**
UP / DOWN
(device-dependent)



appropriate handle
Part-No.: 180.0131.1

2 Handle ABITIG® GRIP

- 2.1  **BIS-51**
ED = Single push-button
- 2.2  **BIS-52**
DD = Double push-button / Button long
- 2.3  **BIS-54 / -64 / -74 / -84 / -94**
DDP = Double push-button / Poti **xx** KΩ
(see page 4.3)
- 2.4  **BIS-59**
EDP = Single push-button / Poti 10 KΩ
(compatible with Migatronic)
- 2.5  **BIS-60**
DD = Double push-button / Button long
for high switching current up to 2 A
(e. g. Dalex, Messer-Lincoln)
- 2.6  **BIS-65**
UD = UP / DOWN
(device-dependent)
- 2.7  **BIS-67**
DD = Double push-button / Compensator
- 2.8  **BIS-95**
UD = UP / DOWN
(compatible with Lorch)



appropriate handle
Part-No.: 180.0130.1

Abbreviations for switch functions:

- ED Single push-button
- DD Double push-button
- UD UP / DOWN (two switches)
- EDP* Single push-button with Potentiometer 10 kΩ,
other factors on request
(e.g. 1.0 kΩ, 2.2 kΩ, 4.7 kΩ, 47 kΩ)
- DDP* Double push-button with Potentiometer 10 kΩ,
other factors on request
(e.g. 1.0 kΩ, 2.2 kΩ, 4.7 kΩ, 47 kΩ)

*In the case of potentiometer regulation in the handle, an HF-filter is essential if the potentiometer cable runs through the remote control connector and is started with high voltage pulses. If there is no HF-filter, the HF pulses may damage the control electronics.

Please order the HF-control cable filter DGF 3 by using the Part-No. 184.0162.

Please note: All trademarks mentioned in this catalogue are property of the respective companies.

Notes

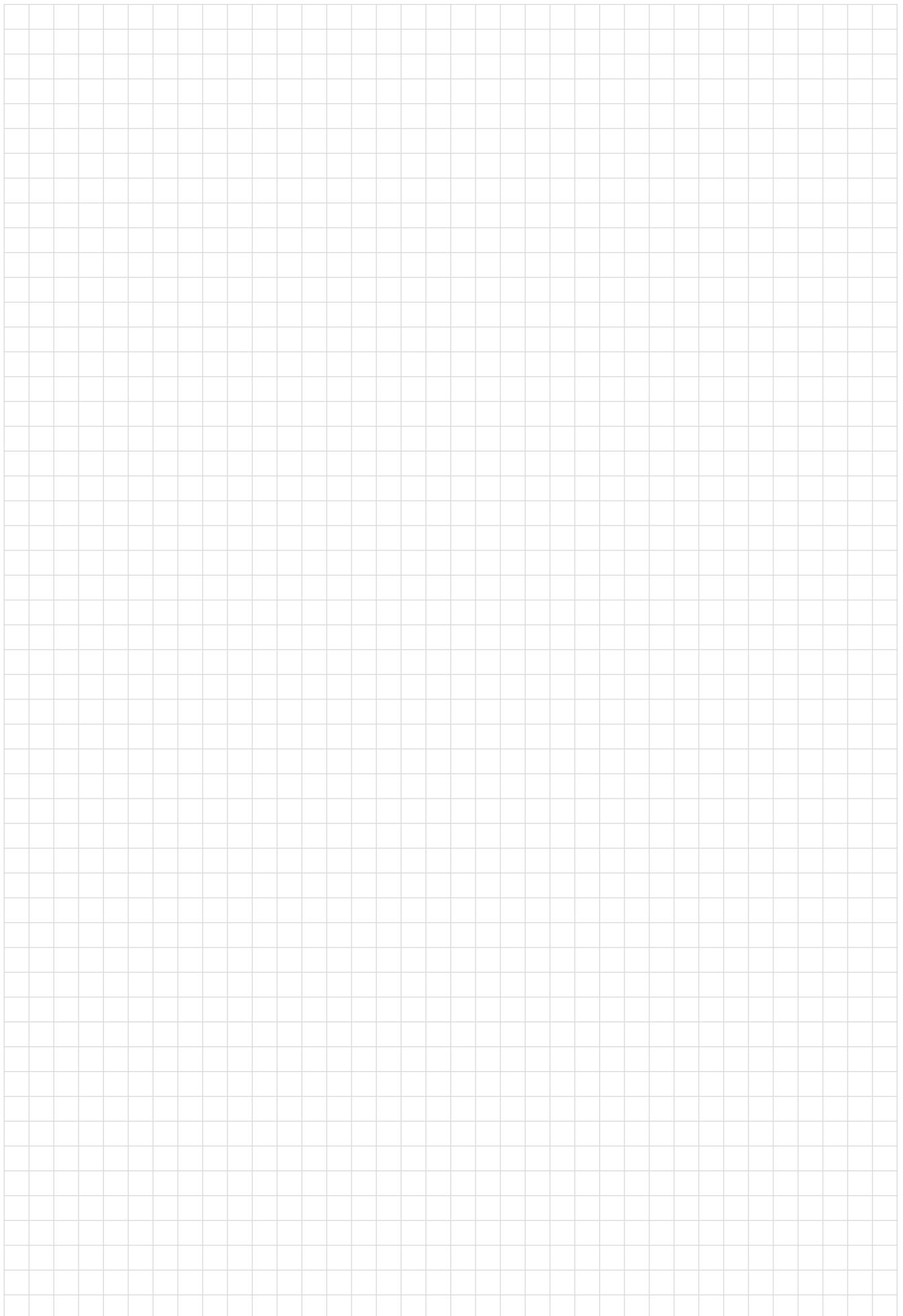



Cable assembly components **BHS** for manual Welding Torches **ABITIG® GRIP** and **ABITIG® GRIP Little** air and liquid cooled

■ **ABITIG® GRIP** 9 / 12-1 / 17 / 18 / 18 SC / 20 /
24 G / 24 W / 26

Page 5.2-5.5

■ **ABITIG® GRIP** 150 / 200 / 260 W / 450 W / 450 W SC

Page 5.6-5.7

■ **ABITIG® GRIP Little** 9 / 17 / 20 / 24 G / 24 W /
150 / 260

Page 5.8-5.10

Cable assembly components ABITIG® GRIP

ABITIG® GRIP 9 / 17 / 24 G / 26

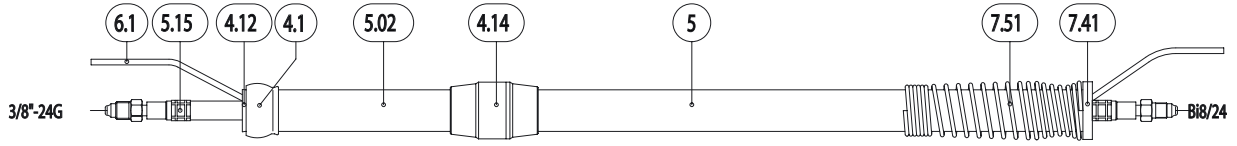
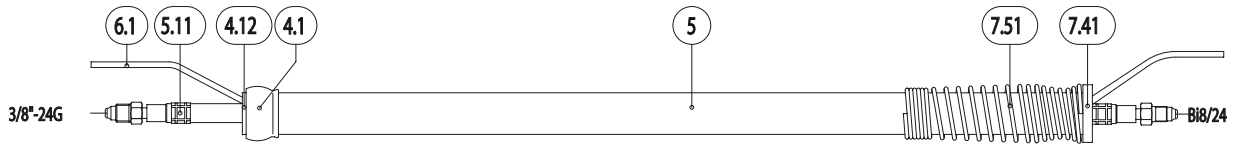

ABITIG® GRIP 20 / 24 W

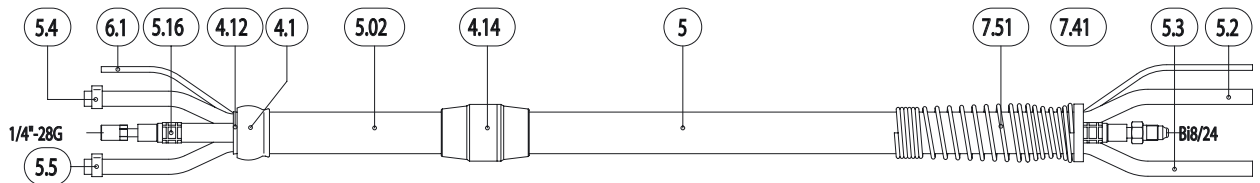
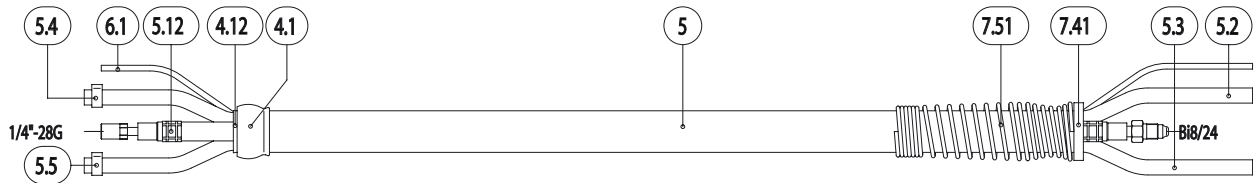

ABITIG® GRIP 18 / 18 SC

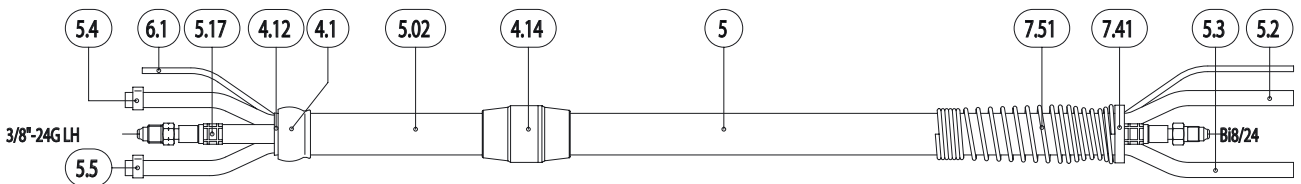
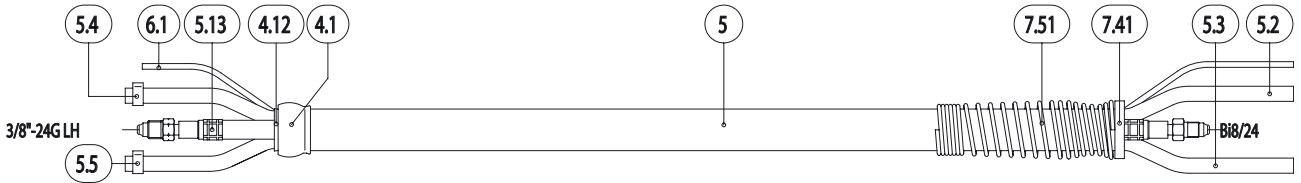

ABITIG® GRIP 12-1

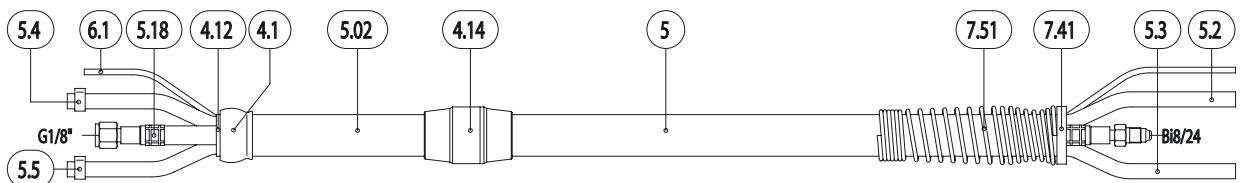
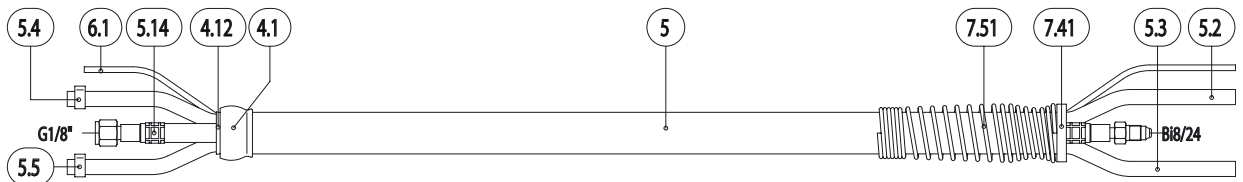

Cable assembly components ABITIG® GRIP

Pos.	Description	Units	Part-No.	Product-group
	Ball joint and outer hose			
4.1	Socket joint ABITIG® GRIP		400.1258	2005
4.12	Strain relief		400.0351	2005
4.14	Hose coupling cpl.		400.0391	2005
4.14	Hose coupling BS		400.0377	2005
4.14	Strain relief		400.0351	2005
4.14	Hose coupling MS		400.0378	2005
	Outer hose and leather hose			
5	Hose 10 black Ø 22x1.25	40 m	109.0020	4050
5.02	Leather hose High Flex Ø 23x1 (0.8 m)		108.0028	2005
	Power cable standard			
5.11	Power cable (ABITIG® 9, ABITIG® 17, ABITIG® 24 G) for 4.00 m		150.0084	2005
5.11	Power cable (ABITIG® 9, ABITIG® 17, ABITIG® 24 G) for 8.00 m		150.0085	2005
5.11	Power cable (ABITIG® 9, ABITIG® 17, ABITIG® 24 G) for 12.00 m		150.0086	2005
5.11	Power cable (ABITIG® 26) for 4.00 m		150.0087	2005
5.11	Power cable (ABITIG® 26) for 8.00 m		150.0088	2005
5.11	Power cable (ABITIG® 26) for 12.00 m		150.0089	2005
5.12	Power cable (ABITIG® 20, ABITIG® 24 W) for 4.00 m		150.0015	2005
5.12	Power cable (ABITIG® 20, ABITIG® 24 W) for 8.00 m		150.0016	2005
5.12	Power cable (ABITIG® 20, ABITIG® 24 W) for 12.00 m		150.0017	2005
5.13	Power cable (ABITIG® 18, ABITIG® 18 SC) for 4.00 m		150.0018	2005
5.13	Power cable (ABITIG® 18, ABITIG® 18 SC) for 8.00 m		150.0019	2005
5.13	Power cable (ABITIG® 18, ABITIG® 18 SC) for 12.00 m		150.0020	2005
5.14	Power cable (ABITIG® 12-1) for 4.00 m		150.0074	2005
5.14	Power cable (ABITIG® 12-1) for 8.00 m		150.0075	2005
5.14	Power cable (ABITIG® 12-1) for 12.00 m		150.0076	2005
	Power cable High Flex			
5.15	Power cable High Flex (ABITIG® 9) for 4.00 m		150.0056	2005
5.15	Power cable High Flex (ABITIG® 9) for 8.00 m		150.0057	2005
5.15	Power cable High Flex (ABITIG® 9) for 12.00 m		150.0058	2005
5.15	Power cable High Flex (ABITIG® 17, ABITIG® 24 G) for 4.00 m		150.0065	2005
5.15	Power cable High Flex (ABITIG® 17, ABITIG® 24 G) for 8.00 m		150.0066	2005
5.15	Power cable High Flex (ABITIG® 17, ABITIG® 24 G) for 12.00 m		150.0067	2005
5.15	Power cable High Flex (ABITIG® 26) for 4.00 m		150.0059	2005
5.15	Power cable High Flex (ABITIG® 26) for 8.00 m		150.0060	2005
5.15	Power cable High Flex (ABITIG® 26) for 12.00 m		150.0061	2005
5.16	Power cable High Flex (ABITIG® 20, ABITIG® 24 W) for 4.00 m		150.0062	2005
5.16	Power cable High Flex (ABITIG® 20, ABITIG® 24 W) for 8.00 m		150.0063	2005
5.16	Power cable High Flex (ABITIG® 20, ABITIG® 24 W) for 12.00 m		150.0064	2005
5.17	Power cable High Flex (ABITIG® 18, ABITIG® 18 SC) for 4.00 m		150.0068	2005
5.17	Power cable High Flex (ABITIG® 18, ABITIG® 18 SC) for 8.00 m		150.0069	2005
5.17	Power cable High Flex (ABITIG® 18, ABITIG® 18 SC) for 12.00 m		150.0070	2005
5.18	Power cable High Flex (ABITIG® 12-1) for 4.00 m		150.0071	2005
5.18	Power cable High Flex (ABITIG® 12-1) for 8.00 m		150.0072	2005
5.18	Power cable High Flex (ABITIG® 12-1) for 12.00 m		150.0073	2005
	Gas hose, water hose, hose clamp and code colour ring			
5.2	Hose Ø 3x1.5	100 m	102.0124	4050
5.3	Hose 1 black Ø 3.9x1.5	100 m	109.0011	4050
5.4	Hose clamp Ø 8.2 mm with ring (mark 8.7)	20 Pcs.	173.0005	9010
w/o. fig.	Code colour ring red	20 Pcs.	501.2166	9010
w/o. fig.	Code colour ring blue	20 Pcs.	501.2167	9010
5.5	Hose clamp Ø 7.5 mm with ring (mark 8.0)	20 Pcs.	173.0007	9010
	Control cable			
6.1	Control cable 3-pole	100 m	100.0100	4050
6.1	Control cable 6-pole	100 m	100.0112	4050
6.1	Control cable 7-pole; protected	100 m	100.0028	4050

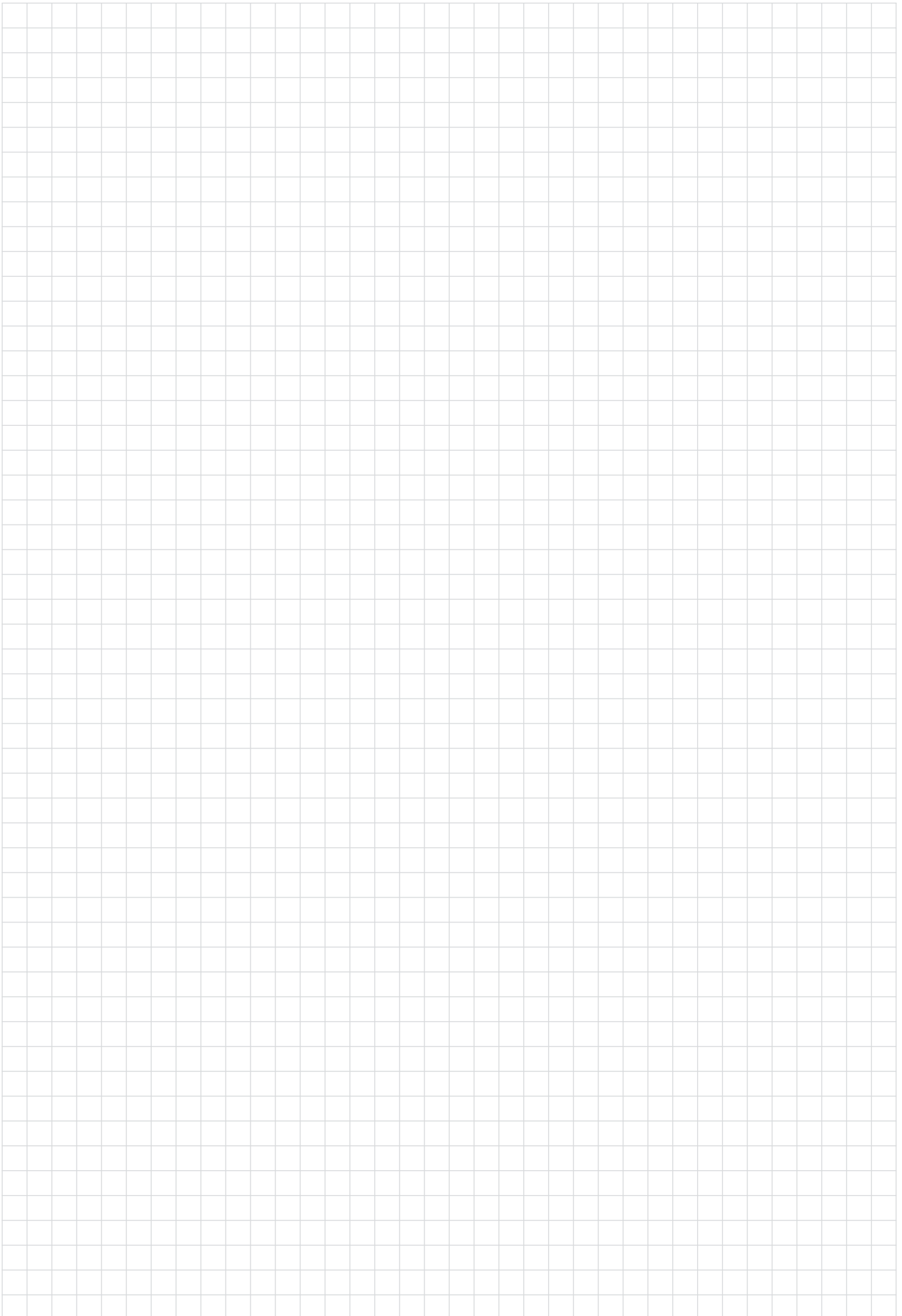

Cable assembly components ABITIG® GRIP

ABITIG® GRIP 150 / 200

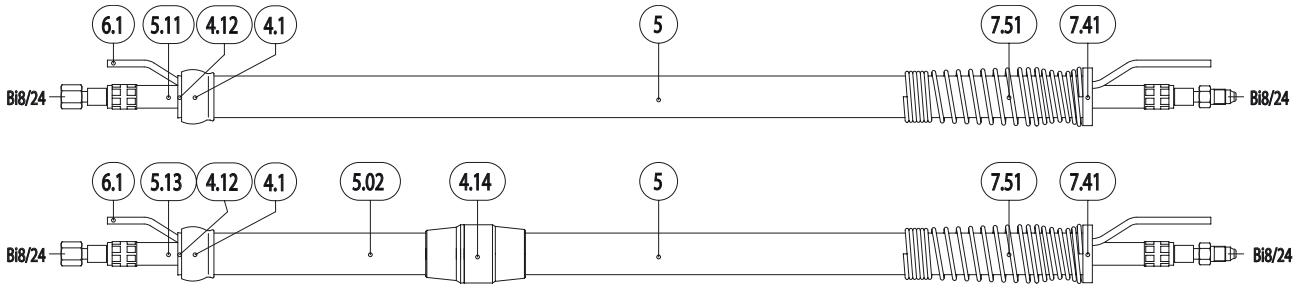

ABITIG® GRIP 260 W / 450 W

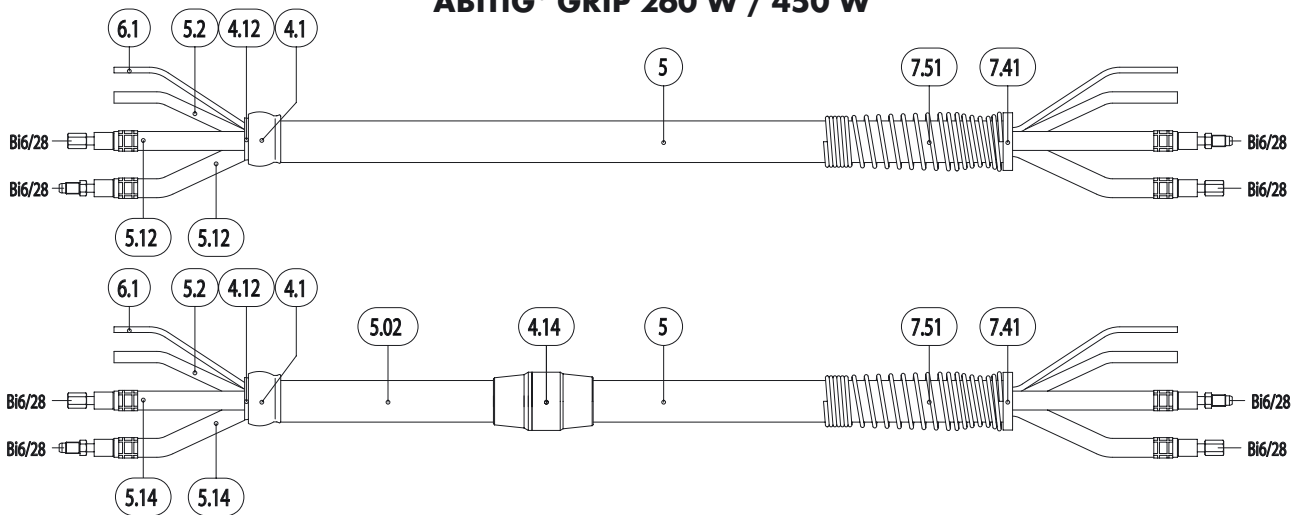

ABITIG® GRIP 450 W SC

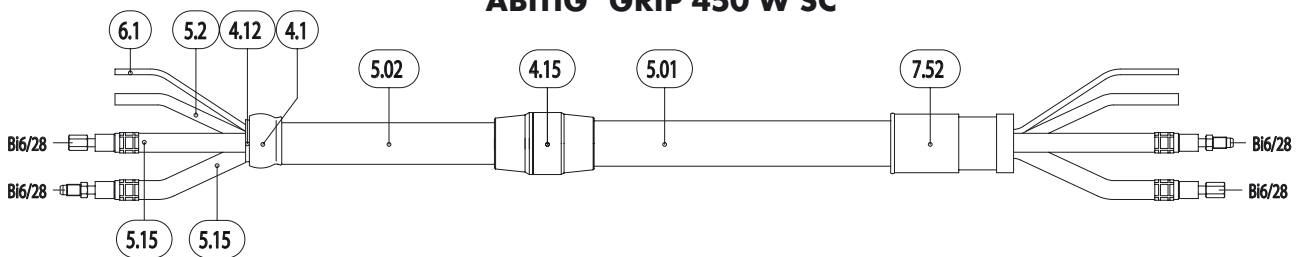

Cable assembly components ABITIG® GRIP

Pos.	Description	Units	Part-No.	Product-group
Ball joint and outer hose				
4.1	Socket joint ABITIG® GRIP		400.1258	2005
4.12	Strain relief		400.0351	2005
4.14	Hose coupling cpl.		400.0391	2005
4.14	Hose coupling BS		400.0377	2005
4.14	Strain relief		400.0351	2005
4.14	Hose coupling MS		400.0378	2005
4.15	Hose coupling cpl.		400.0392	2005
4.15	Hose coupling BS		400.0380	2005
4.15	Strain relief		400.0379	2005
4.15	Hose coupling MS		400.0381	2005
Outer hose and leather hose				
5	Hose 10 black Ø 22x1.25	40 m	109.0020	4050
5.01	Outer cover rubber Ø 25x1.25	40 m	105.0019	4050
5.02	Leather hose High Flex Ø 23x1 (0.8 m)		108.0028	2005
Power cable standard				
5.11	Power cable (ABITIG® 150) for 4.00 m		150.0111	2555
5.11	Power cable (ABITIG® 150) for 8.00 m		150.0112	2555
5.11	Power cable (ABITIG® 150) for 12.00 m		150.0113	2555
5.11	Power cable (ABITIG® 200) for 4.00 m		150.0170	2555
5.11	Power cable (ABITIG® 200) for 8.00 m		150.0171	2555
5.11	Power cable (ABITIG® 200) for 12.00 m		150.0172	2555
5.12	Power cable (ABITIG® 260 W) for 4.00 m		150.0099	2555
5.12	Power cable (ABITIG® 260 W) for 8.00 m		150.0100	2555
5.12	Power cable (ABITIG® 260 W) for 12.00 m		150.0101	2555
5.12	Power cable (ABITIG® 450 W) for 4.00 m		150.0054	2555
5.12	Power cable (ABITIG® 450 W) for 8.00 m		150.0055	2555
5.12	Power cable (ABITIG® 450 W) for 12.00 m		150.0083	2555
Power cable High Flex				
5.13	Power cable High Flex (ABITIG® 150) for 4.00 m		150.0040	2555
5.13	Power cable High Flex (ABITIG® 150) for 8.00 m		150.0041	2555
5.13	Power cable High Flex (ABITIG® 150) for 12.00 m		150.0190	2555
5.13	Power cable High Flex (ABITIG® 200) for 4.00 m		150.0036	2555
5.13	Power cable High Flex (ABITIG® 200) for 8.00 m		150.0037	2555
5.13	Power cable High Flex (ABITIG® 200) for 12.00 m		150.0114	2555
5.14	Power cable High Flex (ABITIG® 260 W) for 4.00 m		150.0164	2555
5.14	Power cable High Flex (ABITIG® 260 W) for 8.00 m		150.0165	2555
5.14	Power cable High Flex (ABITIG® 260 W) for 12.00 m		150.0166	2555
5.14	Power cable High Flex (ABITIG® 450 W) for 4.00 m		150.0167	2555
5.14	Power cable High Flex (ABITIG® 450 W) for 8.00 m		150.0168	2555
5.14	Power cable High Flex (ABITIG® 450 W) for 12.00 m		150.0169	2555
5.15	Power cable High Flex (ABITIG® 450 W SC) for 4.00 m		150.0203	2555
5.15	Power cable High Flex (ABITIG® 450 W SC) for 8.00 m		150.0194	2555
5.15	Power cable High Flex (ABITIG® 450 W SC) for 12.00 m		150.0204	2555
Gas hose and hose clamp				
5.2	Hose Ø 3x1.5	100 m	102.0124	4050
5.5	Hose clamp Ø 7.5 mm with ring (mark 8.0)	20 Pcs.	173.0007	9010
Control cable				
6.1	Control cable 3-pole	100 m	100.0100	4050
6.1	Control cable 6-pole	100 m	100.0112	4050
6.1	Control cable 7-pole; protected	100 m	100.0028	4050
Cable support, cable support spring and strain relief				
7.41	Strain relief		500.0252	9010
7.51	Cable support spring		500.0227	9010
7.52	Cable support		500.0160	9010

Cable assembly components ABITIG® GRIP Little

ABITIG® GRIP Little 9 / 17 / 24 G

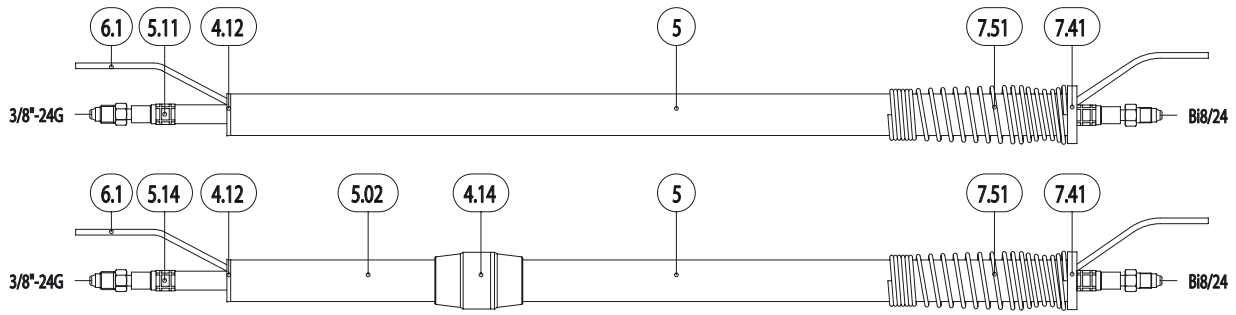

ABITIG® GRIP Little 20 / 24 W

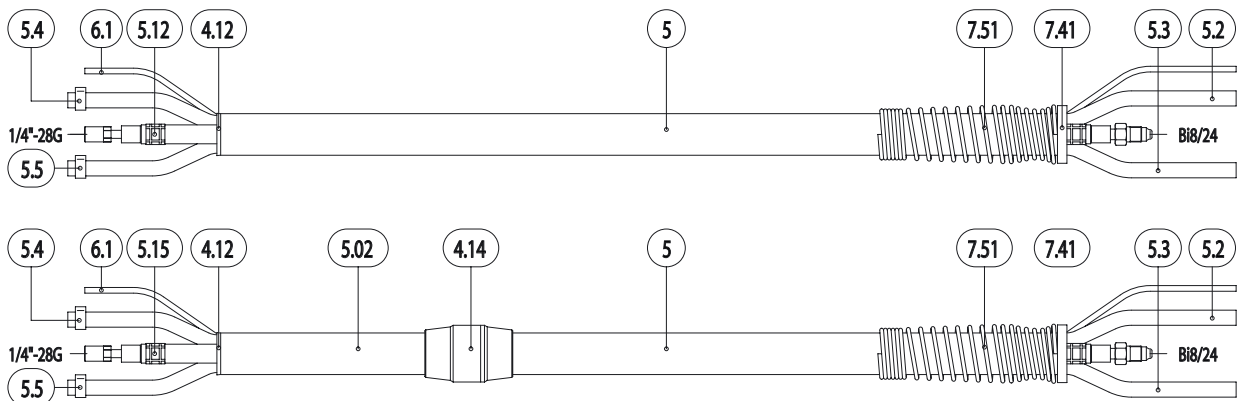

ABITIG® GRIP Little 150

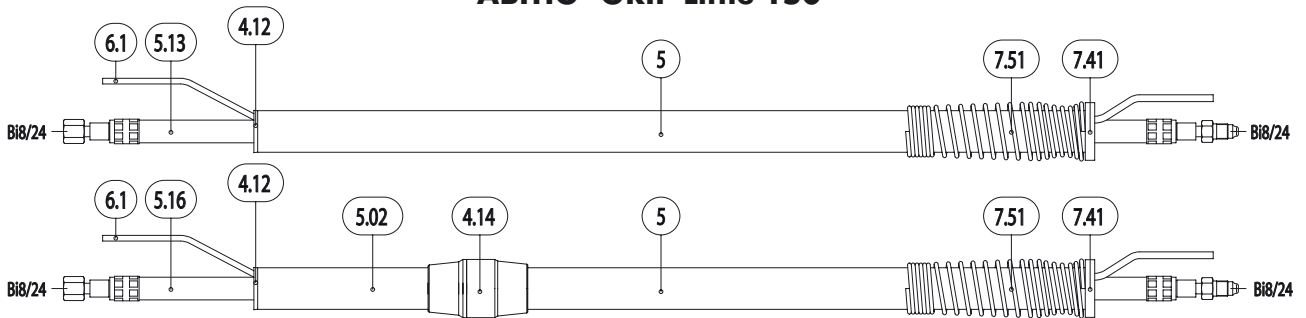

ABITIG® GRIP Little 260

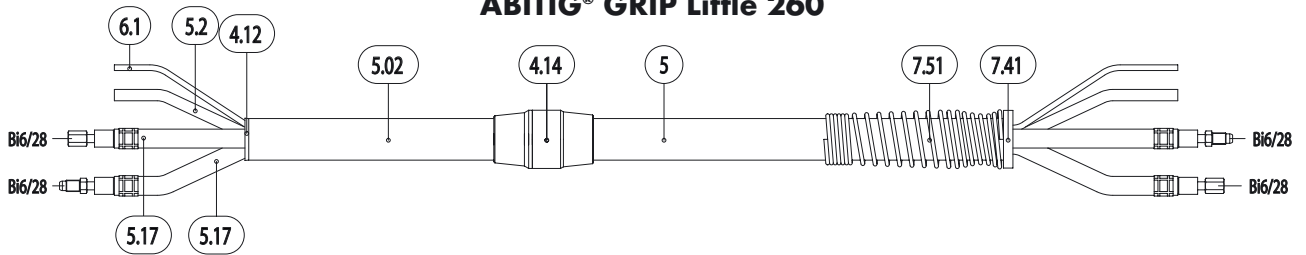

Cable assembly components ABITIG® GRIP Little

Pos.	Description	Units	Part-No.	Product-group
	Ball joint and outer hose			
4.12	Strain relief		400.0351	2005
4.14	Hose coupling cpl.		400.0391	2005
4.14	Hose coupling BS		400.0377	2005
4.14	Strain relief		400.0351	2005
4.14	Hose coupling MS		400.0378	2005
	Outer hose and leather hose			
5	Hose 10 black Ø 22x1.25	40 m	109.0020	4050
5.02	Leather hose High Flex Ø 23x1 (0.8 m)		108.0028	2005
	Power cable standard			
5.11	Power cable (ABITIG® 9, ABITIG® 17, ABITIG® 24 G) for 4.00 m		150.0084	2005
5.11	Power cable (ABITIG® 9, ABITIG® 17, ABITIG® 24 G) for 8.00 m		150.0085	2005
5.11	Power cable (ABITIG® 9, ABITIG® 17, ABITIG® 24 G) for 12.00 m		150.0086	2005
5.12	Power cable (ABITIG® 20) for 4.00 m		150.0259.1	2005
5.12	Power cable (ABITIG® 20) for 8.00 m		150.0260.1	2005
5.12	Power cable (ABITIG® 20) for 12.00 m		150.0261.1	2005
5.12	Power cable (ABITIG® 20, ABITIG® 24 W) for 4.00 m		150.0015	2005
5.12	Power cable (ABITIG® 20, ABITIG® 24 W) for 8.00 m		150.0016	2005
5.12	Power cable (ABITIG® 20, ABITIG® 24 W) for 12.00 m		150.0017	2005
5.13	Power cable (ABITIG® 150) for 4.00 m		150.0111	2555
5.13	Power cable (ABITIG® 150) for 8.00 m		150.0112	2555
5.13	Power cable (ABITIG® 150) for 12.00 m		150.0113	2555
	Power cable High Flex			
5.14	Power cable High Flex (ABITIG® 9) for 4.00 m		150.0056	2005
5.14	Power cable High Flex (ABITIG® 9) for 8.00 m		150.0057	2005
5.14	Power cable High Flex (ABITIG® 9) for 12.00 m		150.0058	2005
5.14	Power cable High Flex (ABITIG® 17, ABITIG® 24 G) for 4.00 m		150.0065	2005
5.14	Power cable High Flex (ABITIG® 17, ABITIG® 24 G) for 8.00 m		150.0066	2005
5.14	Power cable High Flex (ABITIG® 17, ABITIG® 24 G) for 12.00 m		150.0067	2005
5.15	Power cable High Flex (ABITIG® 20) for 4.00 m		150.0255.1	2005
5.15	Power cable High Flex (ABITIG® 20) for 8.00 m		150.0256.1	2005
5.15	Power cable High Flex (ABITIG® 20) for 12.00 m		150.0257.1	2005
5.15	Power cable High Flex (ABITIG® 20, ABITIG® 24 W) for 4.00 m		150.0062	2005
5.15	Power cable High Flex (ABITIG® 20, ABITIG® 24 W) for 8.00 m		150.0063	2005
5.15	Power cable High Flex (ABITIG® 20, ABITIG® 24 W) for 12.00 m		150.0064	2005
5.16	Power cable High Flex (ABITIG® 150) for 4.00 m		150.0040	2555
5.16	Power cable High Flex (ABITIG® 150) for 8.00 m		150.0041	2555
5.16	Power cable High Flex (ABITIG® 150) for 12.00 m		150.0190	2555
5.17	Power cable High Flex (ABITIG® 260 W) for 4.00 m		150.0002	2555
5.17	Power cable High Flex (ABITIG® 260 W) for 8.00 m		150.0003	2555
5.17	Power cable High Flex (ABITIG® 260 W) for 12.00 m		150.0082	2555
	Gas hose, water hose, hose clamp and code colour ring			
5.2	Hose Ø 3x1.5	100 m	102.0124	4050
5.3	Hose 1 black Ø 3.9x1.5	100 m	109.0011	4050
5.4	Hose clamp Ø 8.2 mm with ring (mark 8.7)	20 Pcs.	173.0005	9010
w/o. fig.	Code colour ring red	20 Pcs.	501.2166	9010
w/o. fig.	Code colour ring blue	20 Pcs.	501.2167	9010
5.5	Hose clamp Ø 7.5 mm with ring (mark 8.0)	20 Pcs.	173.0007	9010
	Control cable			
6.1	Control cable 3-pole	100 m	100.0100	4050
6.1	Control cable 6-pole	100 m	100.0112	4050
6.1	Control cable 7-pole; protected	100 m	100.0028	4050
	Cable support spring and strain relief			
7.41	Strain relief		500.0252	9010
7.51	Cable support spring		500.0227	9010

Notes

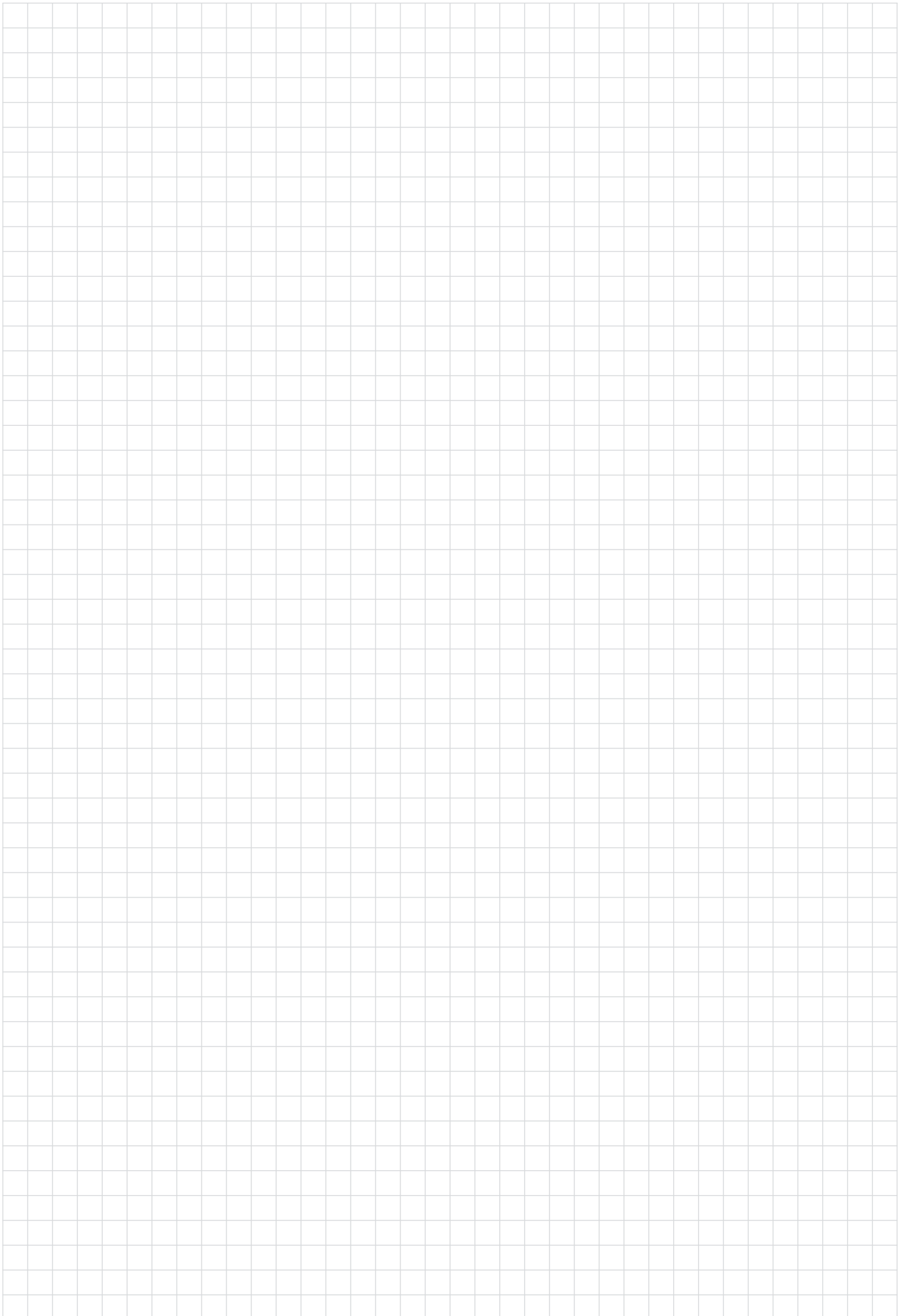

Connecting modules **BCS** for all common TIG Welding power sources Single- and central connectors air or liquid cooled

■ **ABITIG® GRIP, ABITIG® GRIP Little and ABITIG®-MT
(air cooled)**

ABITIG® GRIP 9 / 17 / 24 G / 26 / 150 and 200
ABITIG® GRIP Little 9 / 17 / 24 G and 150
ABITIG®-MT 150 and 200

Page 6.2-6.7

■ **ABITIG® GRIP, ABITIG® GRIP Little and ABITIG®-MT
(liquid cooled)**

ABITIG® GRIP 12-1 / 18 / 18 SC / 20 and 24 W
ABITIG® GRIP Little 20 and 24 W
ABITIG®-MT 260 W / 300 W / 400 W and 500 W

Page 6.8-6.15









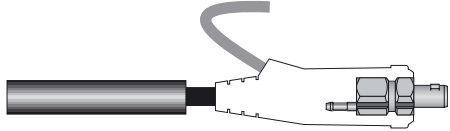
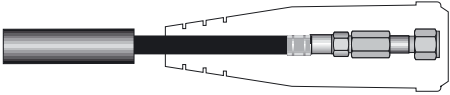
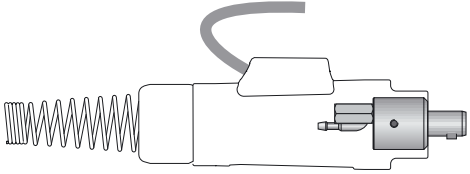
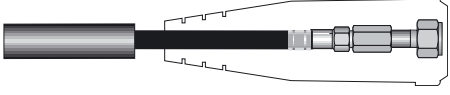
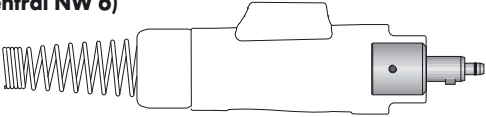

■ **ABITIG® GRIP and ABITIG® GRIP Little
(liquid cooled)**

ABITIG® GRIP 260 W / 450 W and 450 W SC
ABITIG® GRIP Little 260 W

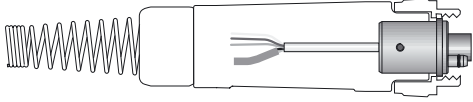
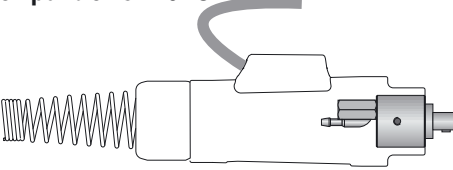

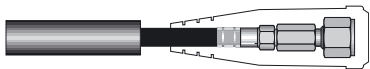
Page 6.16-6.22

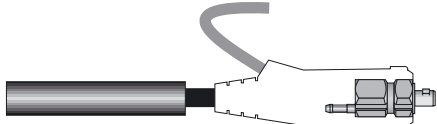

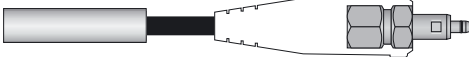
Connecting modules for ABITIG® GRIP / Little / -MT (air cooled)

<p>BCS-00 compatible BSB 35-50</p>  <p style="text-align: right;">①</p>	<p>BCS-09 compatible G1/8"</p>  <p style="text-align: right;">⑩</p>
<p>BCS-01 compatible BSB 35-50</p>  <p style="text-align: right;">②</p>	<p>BCS-11 compatible G1/4"</p>  <p style="text-align: right;">⑪</p>
<p>BCS-02 compatible Lorch (Gas central NW 6)</p>  <p style="text-align: right;">③</p>	<p>BCS-14 compatible 7/8"-14G UNF</p>  <p style="text-align: right;">⑫</p>
<p>BCS-03 compatible GZ</p>  <p style="text-align: right;">④</p>	<p>BCS-15 compatible 9/16"-18G UNF</p>  <p style="text-align: right;">⑬</p>
<p>BCS-04 compatible WTG-5</p>  <p style="text-align: right;">⑤</p>	<p>BCS-17 compatible BSB 10-25</p>  <p style="text-align: right;">⑭</p>
<p>BCS-05 compatible Cloos</p>  <p style="text-align: right;">⑥</p>	<p>BCS-18 compatible Oerlikon</p>  <p style="text-align: right;">⑮</p>
<p>BCS-06 compatible G3/8"</p>  <p style="text-align: right;">⑦</p>	<p>BCS-20 compatible Dalex (Gas central NW 6)</p>  <p style="text-align: right;">⑯</p>
<p>BCS-07 compatible ZA 9-pole</p>  <p style="text-align: right;">⑧</p>	<p>BCS-22 compatible BSB 10-25</p>  <p style="text-align: right;">⑰</p>
<p>BCS-08 compatible M12x1</p>  <p style="text-align: right;">⑨</p>	<p>BCS-23 compatible Lorch (Gas central NW 6)</p>  <p style="text-align: right;">⑱</p>

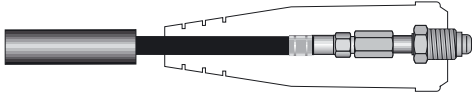
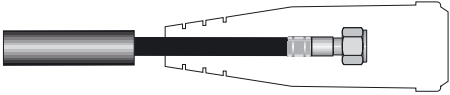
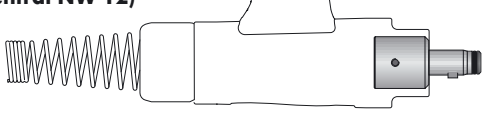
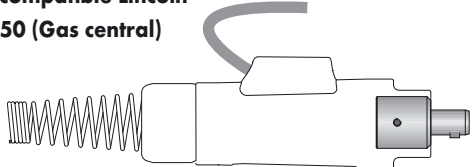
Connecting modules for ABITIG® GRIP / Little / -MT (air cooled)

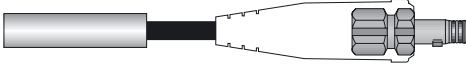
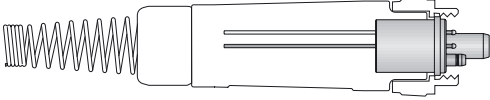
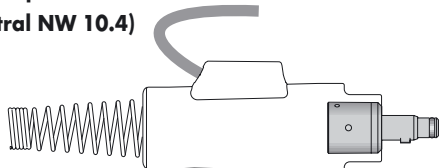
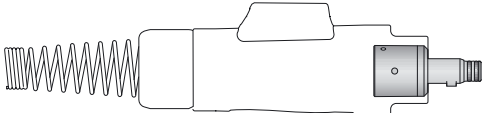
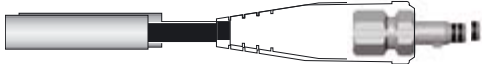
<p>BCS-24 compatible 5/8''-18G UNF</p>  <p style="text-align: right;">(19)</p>	<p>BCS-81 compatible Esseti</p>  <p style="text-align: right;">(28)</p>
<p>BCS-25 compatible Oerlikon (Gas central NW 12)</p>  <p style="text-align: right;">(20)</p>	
<p>BCS-26 compatible Lincoln BSB 35-50 (Gas central)</p>  <p style="text-align: right;">(21)</p>	
<p>BCS-27 compatible BSB 10-25</p>  <p style="text-align: right;">(22)</p>	
<p>BCS-33 compatible SAF (Gas central NW 12.2)</p>  <p style="text-align: right;">(23)</p>	
<p>BCS-34 compatible GZ-2</p>  <p style="text-align: right;">(24)</p>	
<p>BCS-36 compatible Fronius (Gas central NW 10.4)</p>  <p style="text-align: right;">(25)</p>	
<p>BCS-37 compatible Merkle</p>  <p style="text-align: right;">(26)</p>	
<p>BCS-38 compatible Lorch</p>  <p style="text-align: right;">(27)</p>	

Connecting modules for ABITIG® GRIP / Little / -MT (air cooled)

Pos.	Description	Units	Part-No.	Product-group
BCS-00 compatible BSB 35-50				
1	BCS-00 connecting module		771.0521	2005
1	Rubber sleeve		500.0272	9010
1	Hose Ø 3x1.5	100 m	102.0124	4050
1	Hose clamp Ø 6.5 mm with ring (mark 7.0)	20 Pcs.	173.0009	9010
BCS-01 compatible BSB 35-50				
2	BCS-01 connecting module		770.0518	2005
2	Cable support machine side small		500.0432	9010
2	Cable support machine side cover small		500.0433	9010
2	Sealing cover		500.0431	9010
2	Lock ring ND 31		400.0987	9010
2	Cable support spring		500.0227	9010
2	Strain relief		500.0252	9010
2	Pan head screw M4x6	20 Pcs.	000.0552	9010
2	Screw cap 2	20 Pcs.	500.0362	9010
2	Hose Ø 3x1.5	100 m	102.0124	4050
2	Hose clamp Ø 6.5 mm with ring (mark 7.0)	20 Pcs.	173.0009	9010
BCS-02 compatible Lorch (Gas central NW 6)				
3	BCS-02 connecting module		770.0516	2005
3	Cable support machine side small		500.0432	9010
3	Cable support machine side cover small		500.0433	9010
3	Strain relief		500.0252	9010
3	Sealing cover		500.0431	9010
3	Lock ring ND 31		400.0987	9010
3	Cable support spring		500.0227	9010
3	Pan head screw M4x6	20 Pcs.	000.0552	9010
3	Screw cap 2	20 Pcs.	500.0362	9010
BCS-03 compatible GZ				
4	BCS-03 connecting module		770.0581	2005
4	Cable support machine side small		500.0432	9010
4	Cable support machine side cover small		500.0433	9010
4	Strain relief		500.0252	9010
4	Sealing cover		500.0431	9010
4	Lock ring ND 31		400.0987	9010
4	Cable support spring		500.0227	9010
4	Pan head screw M4x6	20 Pcs.	000.0552	9010
4	Screw cap 1	20 Pcs.	500.0251	9010
4	Adaptor nut M33x2		500.0213	9010
BCS-04 compatible WTG-5				
5	BCS-04 connecting module		770.0551	2005
5	Cable support machine side small		500.0427	9010
5	Cable support machine side cover small		500.0428	9010
5	Strain relief		500.0252	9010
5	Lock ring ND 31		400.0987	9010
5	Cable support spring		500.0227	9010
5	Pan head screw M4x6	20 Pcs.	000.0552	9010
5	Screw cap 1	20 Pcs.	500.0251	9010
5	Adaptor nut M33x2		500.0213	9010
BCS-05 compatible Cloos				
6	BCS-05 connecting module		770.0562	2005
6	Cable support machine side small		500.0432	9010
6	Cable support machine side cover small		500.0433	9010
6	Strain relief		500.0252	9010
6	Sealing cover		500.0431	9010
6	Lock ring ND 31		400.0987	9010
6	Cable support spring		500.0227	9010





Connecting modules for ABITIG® GRIP / Little / -MT (air cooled)

Pos.	Description	Units	Part-No.	Product-group
6	Pan head screw M4x6	20 Pcs.	000.0552	9010
6	Screw cap 2	20 Pcs.	500.0362	9010
	BCS-06 compatible G3/8"			
7	BCS-06 connecting module		770.0573	2005
7	Rubber sleeve		511.0398	4001
	BCS-07 compatible ZA 9-pole			
8	BCS-07 connecting module		771.0509	2005
8	Distance ring		771.0502	9010
8	Cable support machine side small		500.0427	9010
8	Cable support machine side cover small		500.0428	9010
8	Strain relief		500.0252	9010
8	Lock ring ND 31		400.0987	9010
8	Cable support spring		500.0227	9010
8	Pan head screw M4x6	20 Pcs.	000.0552	9010
8	Screw cap 2	20 Pcs.	500.0362	9010
8	Adaptor nut		501.0127	9010
	BCS-08 compatible M12x1			
9	BCS-08 connecting module		771.0572	2005
9	Rubber sleeve		511.0398	4001
	BCS-08 compatible G1/8"			
10	BCS-09 connecting module		771.0563	2005
10	Rubber sleeve		511.0398	4001
	BCS-11 compatible G1/4"			
11	BCS-11 connecting module		771.0562	2005
11	Rubber sleeve		511.0398	4001
	BCS-14 compatible 7/8"-14G UNF			
12	BCS-14 connecting module		771.0573	2005
12	Rubber sleeve		511.0398	4001
	BCS-15 compatible 9/16"-18G UNF			
13	BCS-15 connecting module		771.0574	2005
13	Rubber sleeve		511.0398	4001
	BCS-17 compatible BSB 10-25			
14	BCS-17 connecting module		772.0581	2005
14	Cable support machine side small		500.0432	9010
14	Cable support machine side cover small		500.0433	9010
14	Strain relief		500.0252	9010
14	Sealing cover		500.0431	9010
14	Lock ring ND 31		400.0987	9010
14	Cable support spring		500.0227	9010
14	Pan head screw M4x6	20 Pcs.	000.0552	9010
14	Screw cap 2	20 Pcs.	500.0362	9010
14	Hose Ø 3x1.5	100 m	102.0124	4050
14	Hose clamp Ø 6.5 mm with ring (mark 7.0)	20 Pcs.	173.0009	9010
	BCS-18 compatible Oerlikon			
15	BCS-18 connecting module		773.0501	2005
15	Cable support machine side small		500.0432	9010
15	Cable support machine side cover small		500.0433	9010
15	Strain relief		500.0252	9010
15	Sealing cover		500.0431	9010
15	Lock ring ND 31		400.0987	9010
15	Cable support spring		500.0227	9010
15	Pan head screw M4x6	20 Pcs.	000.0552	9010
15	Screw cap 1	20 Pcs.	500.0251	9010
	BCS-20 compatible Dalex (Gas central NW 6)			
16	BCS-20 connecting module		770.0522	2005
16	Cable support machine side small		500.0432	9010



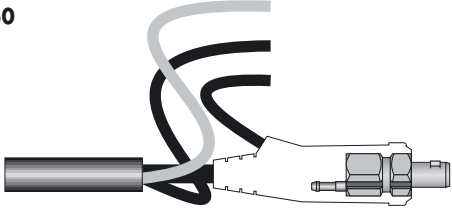
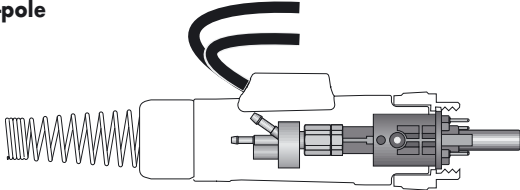

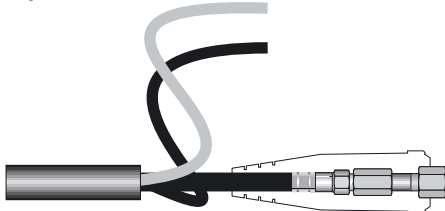
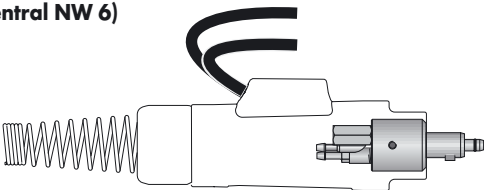
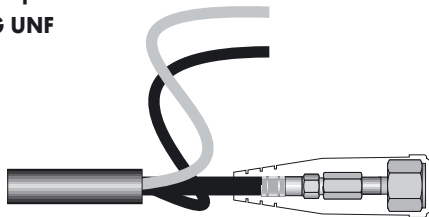
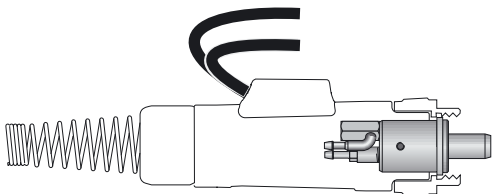
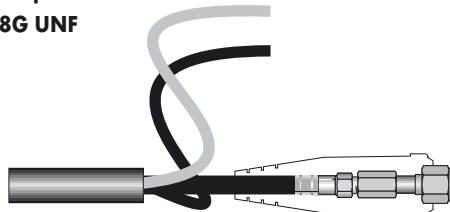
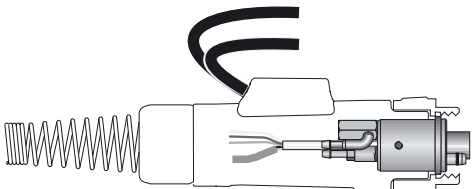
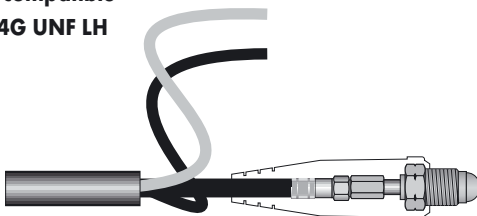
Connecting modules for ABITIG® GRIP / Little / -MT (air cooled)

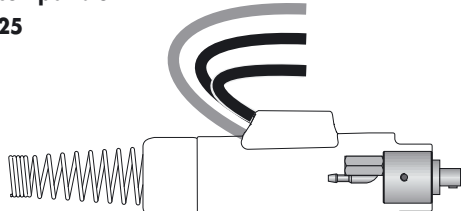
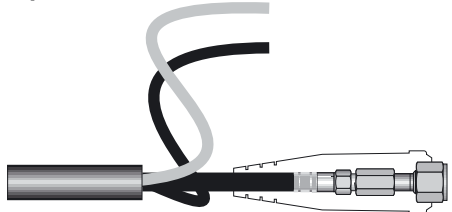
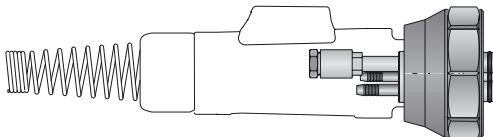
Pos.	Description	Units	Part-No.	Product-group
16	Cable support machine side cover small		500.0433	9010
16	Strain relief		500.0252	9010
16	Sealing cover		500.0431	9010
16	Lock ring ND 31		400.0987	9010
16	Cable support spring		500.0227	9010
16	Pan head screw M4x6	20 Pcs.	000.0552	9010
16	Screw cap 2	20 Pcs.	500.0362	9010
BCS-22 compatible BSB 10-25				
17	BCS-22 connecting module		771.0525	2005
17	Rubber sleeve		500.0272	9010
17	Hose Ø 3x1.5	100 m	102.0124	4050
17	Hose clamp Ø 6.5 mm with ring (mark 7.0)	20 Pcs.	173.0009	9010
BCS-23 compatible Lorch (Gas central NW 6)				
18	BCS-23 connecting module		770.0591	2005
18	Rubber sleeve		500.0271	9010
BCS-24 compatible 5/8"-18G UNF				
19	BCS-24 connecting module		771.0575	2005
19	Rubber sleeve		511.0398	4001
BCS-25 compatible Oerlikon (Gas central NW 12)				
20	BCS-25 connecting module		773.0551	2005
20	Cable support machine side small		500.0432	9010
20	Cable support machine side cover small		500.0433	9010
20	Strain relief		500.0252	9010
20	Sealing cover		500.0431	9010
20	Lock ring ND 31		400.0987	9010
20	Cable support spring		500.0227	9010
20	Pan head screw M4x6	20 Pcs.	000.0552	9010
20	Screw cap 2	20 Pcs.	500.0362	9010
BCS-26 compatible Lincoln BSB 35-50 (Gas central)				
21	BCS-26 connecting module		770.0503	2005
21	Cable support machine side small		500.0432	9010
21	Cable support machine side cover small		500.0433	9010
21	Strain relief		500.0252	9010
21	Sealing cover		500.0431	9010
21	Lock ring ND 31		400.0987	9010
21	Cable support spring		500.0227	9010
21	Pan head screw M4x6	20 Pcs.	000.0552	9010
21	Screw cap 2	20 Pcs.	500.0362	9010
BCS-27 compatible BSB 10-25				
22	BCS-27 connecting module		770.0558	2005
22	Cable support machine side		770.0560	2005
22	Rounded countersunk head screw M4x6	20 Pcs.	009.0201	9010
22	Hose Ø 3x1.5	100 m	102.0124	4050
22	Hose clamp Ø 8.2 mm with ring (mark 8.7)	20 Pcs.	173.0005	9010
22	Hose clamp Ø 7.5 mm with ring (mark 8.0)	20 Pcs.	173.0007	9010
BCS-33 compatible SAF (Gas central NW 12.2)				
23	BCS-33 connecting module		773.0556	2005
23	Rubber sleeve		500.0271	9010
BCS-34 compatible GZ-2				
24	BCS-34 connecting module		770.0576	2005
24	Cable support machine side small		500.0427	9010
24	Cable support machine side cover small		500.0428	9010
24	Strain relief		500.0252	9010
24	Lock ring ND 31		400.0987	9010
24	Cable support spring		500.0227	9010
24	Pan head screw M4x6	20 Pcs.	000.0552	9010

Connecting modules for ABITIG® GRIP / Little / -MT (liquid cooled)

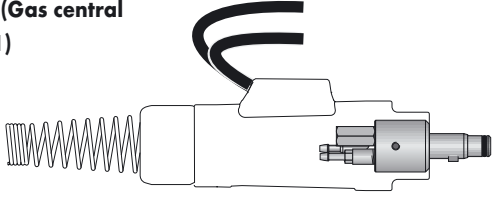
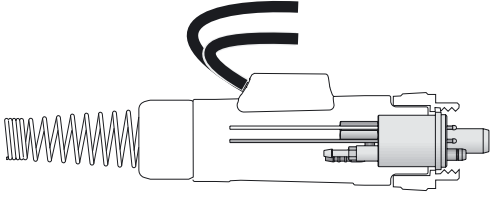
<p>BCS-00 compatible BSB 35-50</p>  <p>①</p>	<p>BCS-07 compatible ZA 9-pole</p>  <p>⑧</p>
<p>BCS-01 compatible BSB 35-50</p>  <p>②</p>	<p>BCS-08 compatible M12x1</p>  <p>⑨</p>
<p>BCS-02 compatible Lorch (Gas central NW 6)</p>  <p>③</p>	<p>BCS-12 compatible 7/8''-14G UNF</p>  <p>⑩</p>
<p>BCS-03 compatible WZ-0</p>  <p>④</p>	<p>BCS-15 compatible 9/16''-18G UNF</p>  <p>⑪</p>
<p>BCS-04 compatible WTW-5</p>  <p>⑤</p>	<p>BCS-16 compatible 7/8''-14G UNF LH</p>  <p>⑫</p>
<p>BCS-05 compatible Cloos</p>  <p>⑥</p>	<p>BCS-17 compatible BSB 10-25</p>  <p>⑬</p>
<p>BCS-06 compatible G3/8''</p>  <p>⑦</p>	<p>BCS-19 compatible Oerlikon</p>  <p>⑭</p>

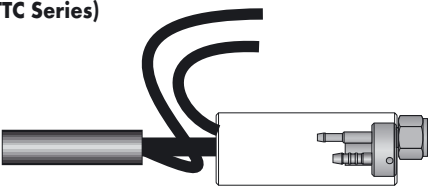
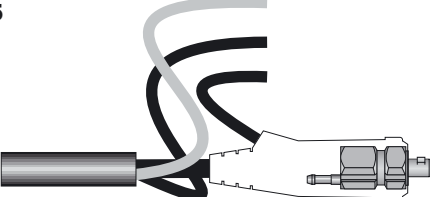
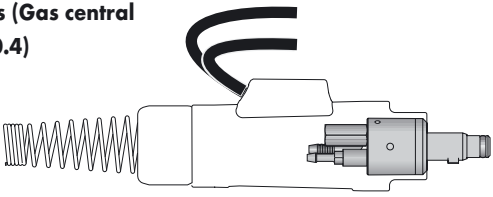
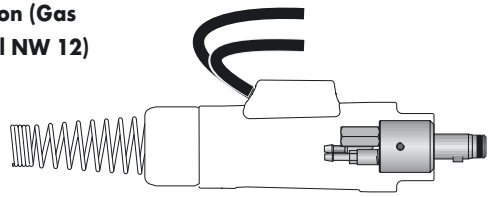
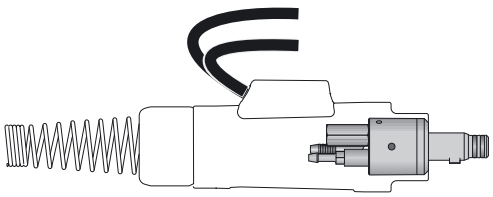
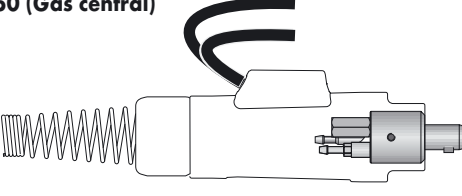
Connecting modules for ABITIG® GRIP / Little / -MT (liquid cooled)

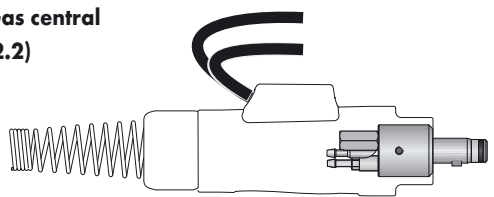
<p>BCS-20 compatible Dalex (Gas central NW 11)</p>  <p>(15)</p>	<p>BCS-34 compatible WZ-2</p>  <p>(22)</p>
<p>BCS-21 compatible Dalex (coolant return flow NW 11)</p>  <p>(16)</p>	<p>BCS-35 compatible Kemppi (TTC Series)</p>  <p>(23)</p>
<p>BCS-22 compatible BSB 10-25</p>  <p>(17)</p>	<p>BCS-36 compatible Fronius (Gas central NW 10.4)</p>  <p>(24)</p>
<p>BCS-25 compatible Oerlikon (Gas zentral NW 12)</p>  <p>(18)</p>	<p>BCS-37 compatible Merkle</p>  <p>(25)</p>
<p>BCS-26 compatible Lincoln BSB 35-50 (Gas central)</p>  <p>(19)</p>	
<p>BCS-27 compatible BSB 10-25</p>  <p>(20)</p>	
<p>BCS-33 compatible SAF (Gas central NW 12.2)</p>  <p>(21)</p>	

Connecting modules for ABITIG® GRIP / Little / -MT (liquid cooled)

Pos.	Description	Units	Part-No.	Product-group
BCS-00 compatible BSB 35-50				
1	BCS-00 connecting module		771.0521	2005
1	Rubber sleeve		500.0272	9010
1	Hose 49 black Ø 3.9x1.5	40 m	109.0059	4050
1	Hose clamp Ø 8.2 mm with ring (mark 8.7)	20 Pcs.	173.0005	9010
BCS-01 compatible BSB 35-50				
2	BCS-01 connecting module		770.0518	2005
2	Cable support machine side small		500.0432	9010
2	Cable support machine side cover small		500.0433	9010
2	Strain relief		500.0252	9010
2	Sealing cover		500.0431	9010
2	Lock ring ND 31		400.0987	9010
2	Cable support spring		500.0227	9010
2	Pan head screw M4x6	20 Pcs.	000.0552	9010
2	Screw cap 2	20 Pcs.	500.0362	9010
2	Hose 49 black Ø 3.9x1.5	40 m	109.0059	4050
2	Hose clamp Ø 8.2 mm with ring (mark 8.7)	20 Pcs.	173.0005	9010
BCS-02 compatible Lorch (Gas central NW 6)				
3	BCS-02 connecting module		772.0512	2005
3	Cable support machine side small		500.0432	9010
3	Cable support machine side cover small		500.0433	9010
3	Strain relief		500.0252	9010
3	Sealing cover		500.0431	9010
3	Lock ring ND 31		400.0987	9010
3	Cable support spring		500.0227	9010
3	Pan head screw M4x6	20 Pcs.	000.0552	9010
3	Screw cap 2	20 Pcs.	500.0362	9010
3	Hose 49 black Ø 3.9x1.5	40 m	109.0059	4050
3	Hose clamp Ø 8.2 mm with ring (mark 8.7)	20 Pcs.	173.0005	9010
3	Hose clamp Ø 7.5 mm with ring (mark 8.0)	20 Pcs.	173.0007	9010
BCS-03 compatible WZ-0				
4	BCS-03 connecting module		770.0583	2005
4	Cable support machine side small		500.0432	9010
4	Cable support machine side cover small		500.0433	9010
4	Strain relief		500.0252	9010
4	Sealing cover		500.0431	9010
4	Lock ring ND 31		400.0987	9010
4	Cable support spring		500.0227	9010
4	Pan head screw M4x6	20 Pcs.	000.0552	9010
4	Screw cap 1	20 Pcs.	500.0251	9010
4	Adaptor nut M33x2		500.0213	9010
4	Hose 49 black Ø 3.9x1.5	40 m	109.0059	4050
4	Hose clamp Ø 8.2 mm with ring (mark 8.7)	20 Pcs.	173.0005	9010
4	Hose clamp Ø 7.5 mm with ring (mark 8.0)	20 Pcs.	173.0007	9010
BCS-04 compatible WTW-5				
5	BCS-04 connecting module		770.0557	2005
5	Cable support machine side small		500.0432	9010
5	Cable support machine side cover small		500.0433	9010
5	Strain relief		500.0252	9010
5	Sealing cover		500.0431	9010
5	Lock ring ND 31		400.0987	9010
5	Cable support spring		500.0227	9010
5	Pan head screw M4x6	20 Pcs.	000.0552	9010
5	Screw cap 1	20 Pcs.	500.0251	9010
5	Adaptor nut M33x2		500.0213	9010
5	Hose 49 black Ø 3.9x1.5	40 m	109.0059	4050

Connecting modules for ABITIG® GRIP / Little / -MT (liquid cooled)

Pos.	Description	Units	Part-No.	Product-group
5	Hose clamp Ø 8.2 mm with ring (mark 8.7)	20 Pcs.	173.0005	9010
5	Hose clamp Ø 7.5 mm with ring (mark 8.0)	20 Pcs.	173.0007	9010
	BCS-05 compatible Cloos			
6	BCS-05 connecting module		770.0562	2005
6	Cable support machine side small		500.0432	9010
6	Cable support machine side cover small		500.0433	9010
6	Strain relief		500.0252	9010
6	Sealing cover		500.0431	9010
6	Lock ring ND 31		400.0987	9010
6	Cable support spring		500.0227	9010
6	Pan head screw M4x6	20 Pcs.	000.0552	9010
6	Screw cap 2	20 Pcs.	500.0362	9010
	BCS-06 compatible G3/8"			
7	BCS-06 connecting module		770.0573	2005
7	Rubber sleeve		511.0398	4001
	BCS-07 compatible ZA 9-pole			
8	BCS-07 connecting module		772.0509	2005
8	Distance ring		771.0502	9010
8	Connector		772.0505	2005
8	Cable support machine side large		500.0415	9010
8	Cable support machine side cover large		500.0416	9010
8	Strain relief		500.0252	9010
8	Sealing cover		500.0431	9010
8	Coupling nut M38x2		400.0137	9010
8	Cable support spring		500.0227	9010
8	Pan head screw M4x6	20 Pcs.	000.0552	9010
8	Screw cap 2	20 Pcs.	500.0362	9010
8	Adaptor nut		501.0127	9010
8	Hose 49 black Ø 3.9x1.5	40 m	109.0059	4050
8	Hose clamp Ø 8.2 mm with ring (mark 8.7)	20 Pcs.	173.0005	9010
8	Hose clamp Ø 7.5 mm with ring (mark 8.0)	20 Pcs.	173.0007	9010
	BCS-08 compatible M12x1			
9	BCS-08 connecting module		771.0572	2005
9	Rubber sleeve		511.0398	4001
	BCS-12 compatible 7/8"-14G UNF			
10	BCS-12 connecting module		772.0586	2005
10	Rubber sleeve		511.0398	4001
	BCS-15 compatible 9/16"-18G UNF			
11	BCS-15 connecting module		771.0574	2005
11	Rubber sleeve		511.0398	4001
	BCS-16 compatible 7/8"-14G UNF LH			
12	BCS-16 connecting module		772.0587	2005
12	Rubber sleeve		511.0398	4001
	BCS-17 compatible BSB 10-25			
13	BCS-17 connecting module		772.0581	2005
13	Cable support machine side small		500.0432	9010
13	Cable support machine side cover small		500.0433	9010
13	Strain relief		500.0252	9010
13	Sealing cover		500.0431	9010
13	Lock ring ND 31		400.0987	9010
13	Cable support spring		500.0227	9010
13	Pan head screw M4x6	20 Pcs.	000.0552	9010
13	Screw cap 2	20 Pcs.	500.0362	9010
13	Hose 49 black Ø 3.9x1.5	40 m	109.0059	4050
13	Hose clamp Ø 8.2 mm with ring (mark 8.7)	20 Pcs.	173.0005	9010

Connecting modules for ABITIG® GRIP / Little / -MT (liquid cooled)

Pos.	Description	Units	Part-No.	Product-group
BCS-19 compatible Oerlikon				
14	BCS-19 connecting module		773.0511	2005
14	Nipple		773.0519	2005
14	Adaptor nut		772.0597	2005
14	Cable support machine side small		500.0432	9010
14	Cable support machine side cover small		500.0433	9010
14	Strain relief		500.0252	9010
14	Sealing cover		500.0431	9010
14	Lock ring ND 31		400.0987	9010
14	Cable support spring		500.0227	9010
14	Pan head screw M4x6	20 Pcs.	000.0552	9010
14	Screw cap 2	20 Pcs.	500.0362	9010
14	Hose clamp Ø 5.7 mm with ring (mark 6.1)	20 Pcs.	173.0008	9010
BCS-20 compatible Dalex (Gas central NW 11)				
15	BCS-20 connecting module		770.0523	2005
15	Cable support machine side small		500.0432	9010
15	Cable support machine side cover small		500.0433	9010
15	Strain relief		500.0252	9010
15	Sealing cover		500.0431	9010
15	Lock ring ND 31		400.0987	9010
15	Cable support spring		500.0227	9010
15	Pan head screw M4x6	20 Pcs.	000.0552	9010
15	Screw cap 2	20 Pcs.	500.0362	9010
15	Hose 49 black Ø 3.9x1.5	40 m	109.0059	4050
15	Hose clamp Ø 8.2 mm with ring (mark 8.7)	20 Pcs.	173.0005	9010
15	Hose clamp Ø 7.5 mm with ring (mark 8.0)	20 Pcs.	173.0007	9010
BCS-21 compatible Dalex (Coolant return flow central NW 11)				
16	BCS-21 connecting module		773.0534	2005
16	Cable support machine side small		500.0432	9010
16	Cable support machine side cover small		500.0433	9010
16	Strain relief		500.0252	9010
16	Sealing cover		500.0431	9010
16	Lock ring ND 31		400.0987	9010
16	Cable support spring		500.0227	9010
16	Pan head screw M4x6	20 Pcs.	000.0552	9010
16	Screw cap 2	20 Pcs.	500.0362	9010
BCS-22 compatible BSB 10-25				
17	BCS-22 connecting module		771.0525	2005
17	Rubber sleeve		500.0272	9010
17	Hose 49 black Ø 3.9x1.5	40 m	109.0059	4050
17	Hose clamp Ø 8.2 mm with ring (mark 8.7)	20 Pcs.	173.0005	9010
BCS-25 compatible Oerlikon (Gas central NW 12)				
18	BCS-25 connecting module		773.0536	2005
18	Cable support machine side small		500.0432	9010
18	Cable support machine side cover small		500.0433	9010
18	Strain relief		500.0252	9010
18	Sealing cover		500.0431	9010
18	Lock ring ND 31		400.0987	9010
18	Cable support spring		500.0227	9010
18	Pan head screw M4x6	20 Pcs.	000.0552	9010
18	Screw cap 2	20 Pcs.	500.0362	9010
18	Hose 49 black Ø 3.9x1.5	40 m	109.0059	4050
18	Hose clamp Ø 8.2 mm with ring (mark 8.7)	20 Pcs.	173.0005	9010
18	Hose clamp Ø 7.5 mm with ring (mark 8.0)	20 Pcs.	173.0007	9010
BCS-26 compatible Lincoln BSB 35-50 (Gas central)				
19	BCS-26 connecting module		772.0516	2005

Connecting modules for ABITIG® GRIP / Little / -MT (liquid cooled)

Pos.	Description	Units	Part-No.	Product-group
19	Cable support machine side small		500.0432	9010
19	Cable support machine side cover small		500.0433	9010
19	Strain relief		500.0252	9010
19	Sealing cover		500.0431	9010
19	Lock ring ND 31		400.0987	9010
19	Cable support spring		500.0227	9010
19	Pan head screw M4x6	20 Pcs.	000.0552	9010
19	Screw cap 2	20 Pcs.	500.0362	9010
19	Hose 49 black Ø 3.9x1.5	40 m	109.0059	4050
19	Hose clamp Ø 8.2 mm with ring (mark 8.7)	20 Pcs.	173.0005	9010
19	Hose clamp Ø 7.5 mm with ring (mark 8.0)	20 Pcs.	173.0007	9010
BCS-27 compatible BSB 10-25				
20	BCS-27 connecting module		770.0558	2005
20	Cable support machine side		770.0560	2005
20	Rounded countersunk head screw M4x6	20 Pcs.	009.0201	9010
20	Hose 49 black Ø 3.9x1.5	40 m	109.0059	4050
20	Hose clamp Ø 8.2 mm with ring (mark 8.7)	20 Pcs.	173.0005	9010
20	Hose clamp Ø 7.5 mm with ring (mark 8.0)	20 Pcs.	173.0007	9010
BCS-33 compatible SAF (Gas central NW 12.2)				
21	BCS-33 connecting module		773.0537	2005
21	Cable support machine side small		500.0432	9010
21	Cable support machine side cover small		500.0433	9010
21	Strain relief		500.0252	9010
21	Sealing cover		500.0431	9010
21	Lock ring ND 31		400.0987	9010
21	Cable support spring		500.0227	9010
21	Pan head screw M4x6	20 Pcs.	000.0552	9010
21	Screw cap 2	20 Pcs.	500.0362	9010
21	Hose 49 black Ø 3.9x1.5	40 m	109.0059	4050
21	Hose clamp Ø 8.2 mm with ring (mark 8.7)	20 Pcs.	173.0005	9010
21	Hose clamp Ø 7.5 mm with ring (mark 8.0)	20 Pcs.	173.0007	9010
BCS-34 compatible WZ-2				
22	BCS-34 connecting module		770.0577	2005
22	Cable support machine side small		500.0432	9010
22	Cable support machine side cover small		500.0433	9010
22	Strain relief		500.0252	9010
22	Sealing cover		500.0431	9010
22	Lock ring ND 31		400.0987	9010
22	Cable support spring		500.0227	9010
22	Pan head screw M4x6	20 Pcs.	000.0552	9010
22	Screw cap 1	20 Pcs.	500.0251	9010
22	Adaptor nut M33x2		500.0213	9010
22	Hose 49 black Ø 3.9x1.5	40 m	109.0059	4050
22	Hose clamp Ø 8.2 mm with ring (mark 8.7)	20 Pcs.	173.0005	9010
22	Hose clamp Ø 7.5 mm with ring (mark 8.0)	20 Pcs.	173.0007	9010
BCS-35 compatible Kemppi (TTC Series)				
23	BCS-35 connecting module		773.0558	2005
23	Cable support machine side		772.0519	2005
23	Rounded countersunk head screw M4x6	20 Pcs.	009.0201	9010
23	Hose 49 black Ø 3.9x1.5	40 m	109.0059	4050
23	Hose clamp Ø 8.2 mm with ring (mark 8.7)	20 Pcs.	173.0005	9010
23	Hose clamp Ø 7.5 mm with ring (mark 8.0)	20 Pcs.	173.0007	9010
BCS-36 compatible Fronius (Gas central NW 10.4)				
24	BCS-36 connecting module		770.0585	2005
24	Cable support machine side small		500.0432	9010
24	Cable support machine side cover small		500.0433	9010

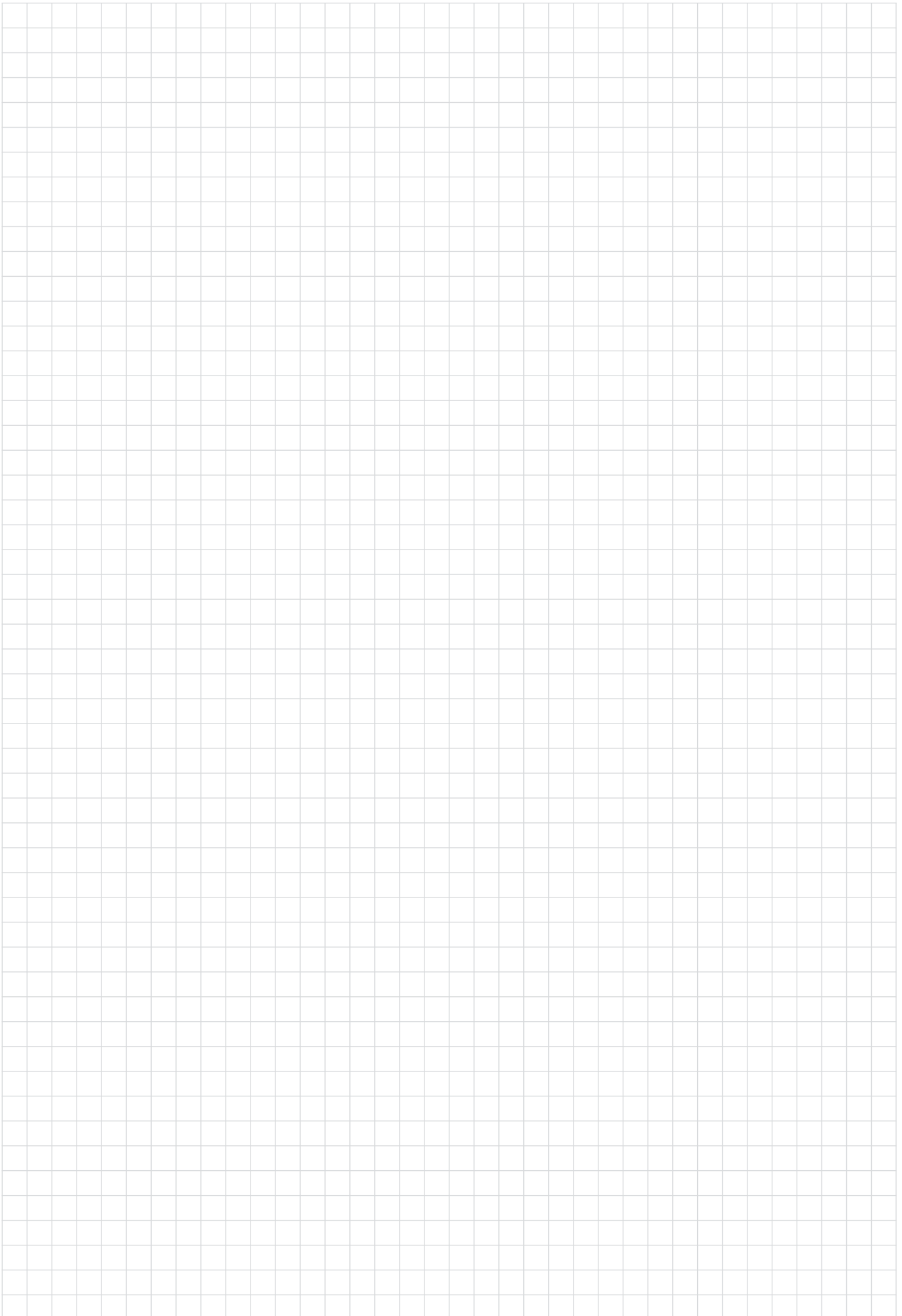

Connecting modules for ABITIG® GRIP 260 W / 450 W / 450 W SC*

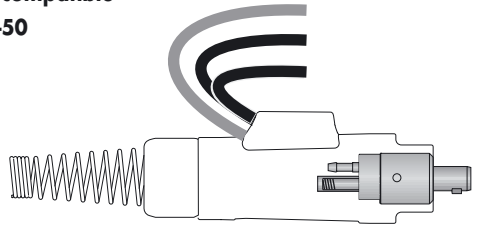
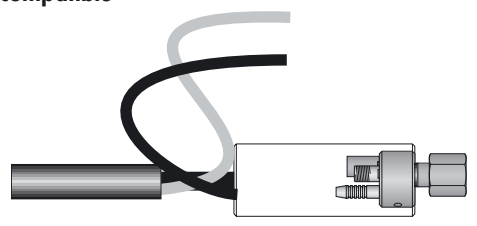
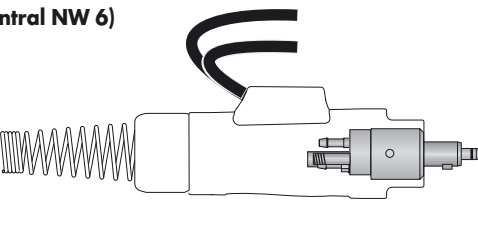
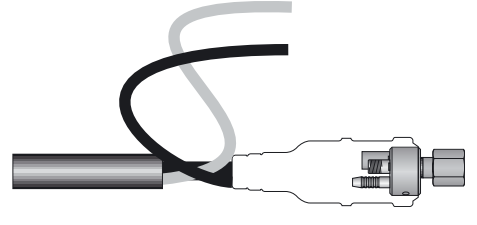
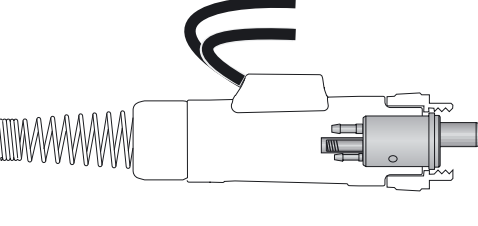
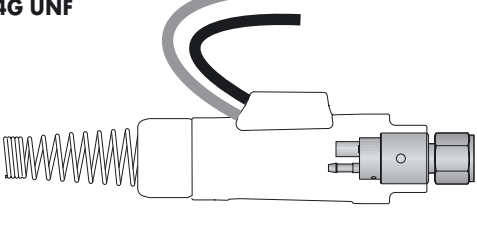
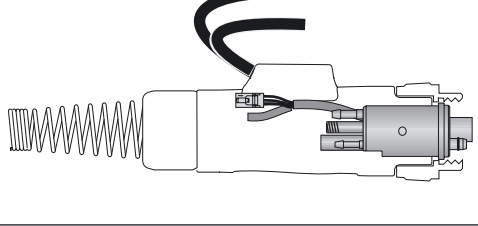
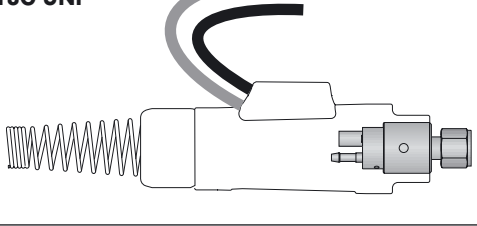
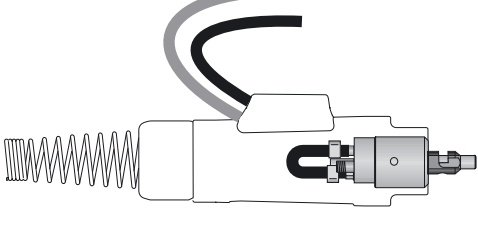
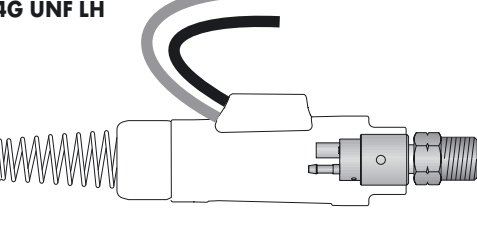
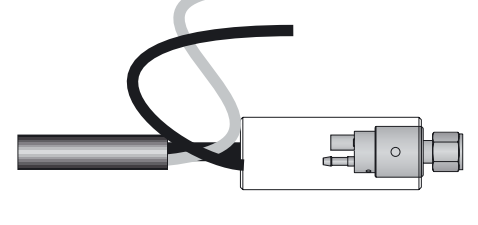
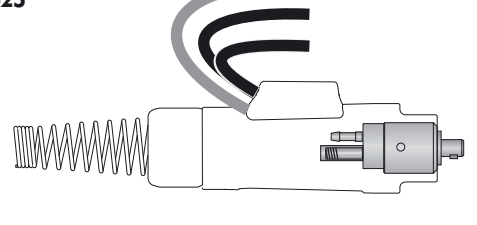
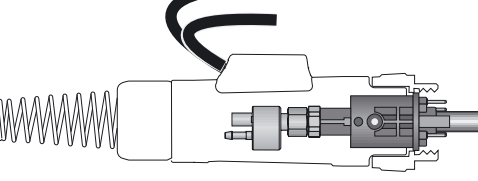
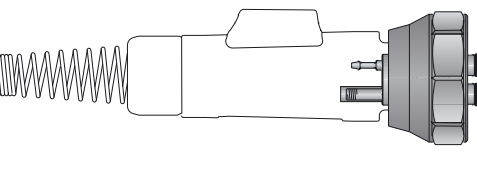
<p>BCS-01 compatible BSB 35-50</p>  <p style="text-align: right;">①</p>	<p>BCS-08 compatible M12x1</p>  <p style="text-align: right;">⑧</p>
<p>BCS-02 compatible Lorch (Gas central NW 6)</p>  <p style="text-align: right;">②</p>	<p>BCS-10 compatible M12x1</p>  <p style="text-align: right;">⑨</p>
<p>BCS-03 compatible WZ-0</p>  <p style="text-align: right;">③</p>	<p>BCS-12 compatible 7/8''-14G UNF</p>  <p style="text-align: right;">⑩</p>
<p>BCS-04 compatible WTW-5</p>  <p style="text-align: right;">④</p>	<p>BCS-15 compatible 9/16''-18G UNF</p>  <p style="text-align: right;">⑪</p>
<p>BCS-05 compatible Cloos</p>  <p style="text-align: right;">⑤</p>	<p>BCS-16 compatible 7/8''-14G UNF LH</p>  <p style="text-align: right;">⑫</p>
<p>BCS-06 compatible G3/8''</p>  <p style="text-align: right;">⑥</p>	<p>BCS-17 compatible BSB 10-25</p>  <p style="text-align: right;">⑬</p>
<p>BCS-07 compatible ZA 9-pole</p>  <p style="text-align: right;">⑦</p>	<p>BCS-19 compatible Oerlikon</p>  <p style="text-align: right;">⑭</p>

Connecting modules for ABITIG® GRIP 260 W / 450 W / 450 W SC*

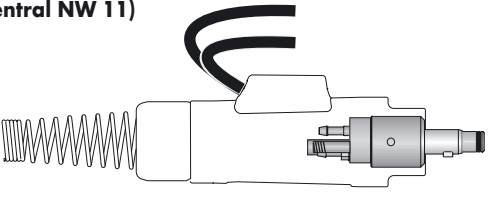
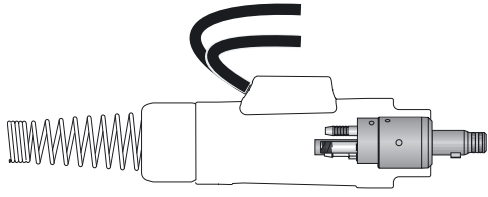
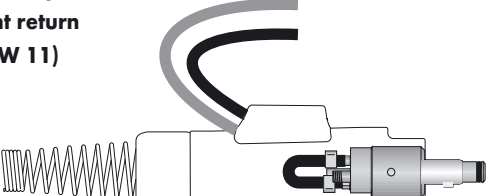
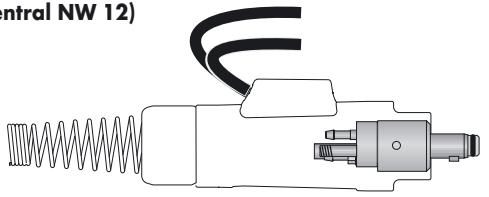
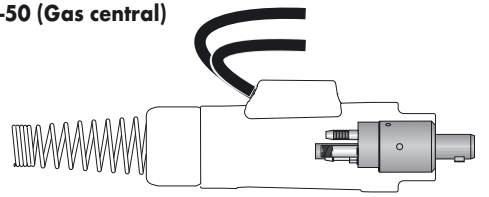
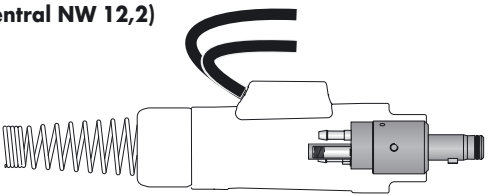
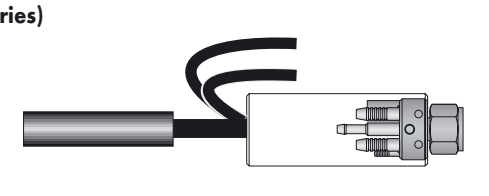
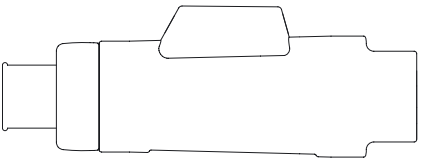
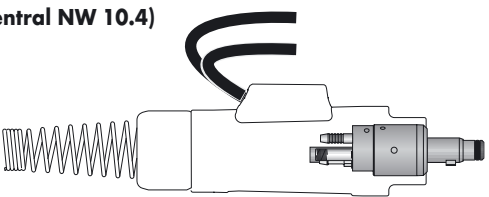
<p>BCS-20 compatible Dalex (Gas central NW 11)</p>  <p style="text-align: right;">(15)</p>	<p>BCS-37 compatible Merkle</p>  <p style="text-align: right;">(22)</p>
<p>BCS-21 compatible Dalex (coolant return flow NW 11)</p>  <p style="text-align: right;">(16)</p>	
<p>BCS-25 compatible Oerlikon (Gas central NW 12)</p>  <p style="text-align: right;">(17)</p>	
<p>BCS-26 compatible Lincoln BSB 35-50 (Gas central)</p>  <p style="text-align: right;">(18)</p>	
<p>BCS-33 compatible SAF (Gas central NW 12,2)</p>  <p style="text-align: right;">(19)</p>	
<p>BCS-35 compatible Kempfi (TTC Series)</p>  <p style="text-align: right;">(20)</p>	<p>* ABITIG® GRIP 450 W SC</p>  <p style="text-align: right;">(99)</p>
<p>BCS-36 compatible Fronius (Gas central NW 10.4)</p>  <p style="text-align: right;">(21)</p>	<p>Please note for ABITIG® GRIP 450 W SC! In opposition to ABITIG® GRIP 260 W and 450 W the components "strain relief" (500.0252) and "cable support spring" (500.0227) will be replaced by the "cable support" (500.0160).</p>

Connecting modules for ABITIG® GRIP 260 W / 450 W / 450 W SC*

Pos.	Description	Units	Part-No.	Product-group
BCS-01 compatible BSB 35-50				
1	BCS-01 connecting module		770.0502	2555
1	Cable support machine side small		500.0432	9010
1	Cable support machine side cover small		500.0433	9010
1	Strain relief		500.0252	9010
1	Sealing cover		500.0431	9010
1	Lock ring ND 31		400.0987	9010
1	Cable support spring		500.0227	9010
1	Pan head screw M4x6	20 Pcs.	000.0552	9010
1	Screw cap 2	20 Pcs.	500.0362	9010
1	Hose 49 black Ø 3.9x1.5	40 m	109.0059	4050
1	Hose clamp Ø 7.5 mm with ring (mark 8.0)	20 Pcs.	173.0007	9010
BCS-02 compatible Lorch (Gas central NW 6)				
2	BCS-02 connecting module		770.0501	2555
2	Cable support machine side small		500.0432	9010
2	Cable support machine side cover small		500.0433	9010
2	Strain relief		500.0252	9010
2	Sealing cover		500.0431	9010
2	Lock ring ND 31		400.0987	9010
2	Cable support spring		500.0227	9010
2	Pan head screw M4x6	20 Pcs.	000.0552	9010
2	Screw cap 2	20 Pcs.	500.0362	9010
2	Hose 49 black Ø 3.9x1.5	40 m	109.0059	4050
2	Hose clamp Ø 6.2 mm with ring (mark 6.6)	20 Pcs.	173.0006	9010
2	Hose clamp Ø 7.5 mm with ring (mark 8.0)	20 Pcs.	173.0007	9010
BCS-03 compatible WZ-0				
3	BCS-03 connecting module		770.0531	2555
3	Cable support machine side small		500.0432	9010
3	Cable support machine side cover small		500.0433	9010
3	Strain relief		500.0252	9010
3	Sealing cover		500.0431	9010
3	Lock ring ND 31		400.0987	9010
3	Cable support spring		500.0227	9010
3	Pan head screw M4x6	20 Pcs.	000.0552	9010
3	Screw cap 1	20 Pcs.	500.0251	9010
3	Adaptor nut M33x2		500.0213	9010
3	Hose 49 black Ø 3.9x1.5	40 m	109.0059	4050
3	Hose clamp Ø 5.7 mm with ring (mark 6.1)	20 Pcs.	173.0008	9010
3	Hose clamp Ø 7.5 mm with ring (mark 8.0)	20 Pcs.	173.0007	9010
BCS-04 compatible WTW-5				
4	BCS-04 connecting module		770.0541	2555
4	Cable support machine side small		500.0432	9010
4	Cable support machine side cover small		500.0433	9010
4	Strain relief		500.0252	9010
4	Sealing cover		500.0431	9010
4	Lock ring ND 31		400.0987	9010
4	Cable support spring		500.0227	9010
4	Pan head screw M4x6	20 Pcs.	000.0552	9010
4	Screw cap 1	20 Pcs.	500.0251	9010
4	Adaptor nut M33x2		500.0213	9010
4	Hose 49 black Ø 3.9x1.5	40 m	109.0059	4050
4	Hose clamp Ø 5.7 mm with ring (mark 6.1)	20 Pcs.	173.0008	9010
4	Hose clamp Ø 7.5 mm with ring (mark 8.0)	20 Pcs.	173.0007	9010
BCS-05 compatible Cloos				
5	BCS-05 connecting module		770.0561	2555
5	Cable support machine side small		500.0432	9010

Connecting modules for ABITIG® GRIP 260 W / 450 W / 450 W SC *

Pos.	Description	Units	Part-No.	Product-group
5	Cable support machine side cover small		500.0433	9010
5	Strain relief		500.0252	9010
5	Sealing cover		500.0431	9010
5	Lock ring ND 31		400.0987	9010
5	Cable support spring		500.0227	9010
5	Pan head screw M4x6	20 Pcs.	000.0552	9010
5	Screw cap 2	20 Pcs.	500.0362	9010
5	Hose 49 black Ø 3.9x1.5	40 m	109.0059	4050
5	Hose clamp Ø 7.5 mm with ring (mark 8.0)	20 Pcs.	173.0007	9010
BCS-06 compatible G3/8"				
6	BCS-06 connecting module		770.0571	2555
6	Cable support machine side		772.0543	2555
6	Rounded countersunk head screw M4x6	20 Pcs.	009.0201	9010
6	Hose 49 black Ø 3.9x1.5	40 m	109.0059	4050
6	Hose clamp Ø 7.5 mm with ring (mark 8.0)	20 Pcs.	173.0007	9010
BCS-07 compatible ZA 9-pole				
7	BCS-07 connecting module		772.0514	2555
7	Distance ring		771.0502	9010
7	Cable support machine side large		500.0415	9010
7	Cable support machine side cover large		500.0416	9010
7	Strain relief		500.0252	9010
7	Sealing cover		500.0431	9010
7	Coupling nut M38x2		400.0137	9010
7	Cable support spring		500.0227	9010
7	Pan head screw M4x6	20 Pcs.	000.0552	9010
7	Screw cap 2	20 Pcs.	500.0362	9010
7	Adaptor nut		501.0127	9010
7	Hose 49 black Ø 3.9x1.5	40 m	109.0059	4050
7	Hose clamp Ø 6.2 mm with ring (mark 6.6)	20 Pcs.	173.0006	9010
7	Hose clamp Ø 7.5 mm with ring (mark 8.0)	20 Pcs.	173.0007	9010
BCS-08 compatible M12x1				
8	BCS-08 / BCS-10 connecting module		772.0521	2555
8	Cable support machine side		772.0543	2555
8	Rounded countersunk head screw M4x6	20 Pcs.	009.0201	9010
8	Hose 49 black Ø 3.9x1.5	40 m	109.0059	4050
8	Hose clamp Ø 7.5 mm with ring (mark 8.0)	20 Pcs.	173.0007	9010
BCS-10 compatible M12x1				
9	BCS-08 / BCS-10 connecting module		772.0521	2555
9	Rubber sleeve		511.0398	4001
9	Hose 49 black Ø 3.9x1.5	40 m	109.0059	4050
9	Hose clamp Ø 7.5 mm with ring (mark 8.0)	20 Pcs.	173.0007	9010
BCS-12 compatible 7/8"-14G UNF				
10	BCS-12 connecting module		772.0531	2555
10	Cable support machine side small		500.0432	9010
10	Cable support machine side cover small		500.0433	9010
10	Strain relief		500.0252	9010
10	Sealing cover		500.0431	9010
10	Lock ring ND 31		400.0987	9010
10	Cable support spring		500.0227	9010
10	Pan head screw M4x6	20 Pcs.	000.0552	9010
10	Screw cap 2	20 Pcs.	500.0362	9010
10	Hose 49 black Ø 3.9x1.5	40 m	109.0059	4050
10	Hose clamp Ø 7.5 mm with ring (mark 8.0)	20 Pcs.	173.0007	9010
BCS-15 compatible 9/16"-18G UNF				
11	BCS-15 connecting module		772.0561	2555
11	Cable support machine side small		500.0432	9010

Connecting modules for ABITIG® GRIP 260 W / 450 W / 450 W SC*

Pos.	Description	Units	Part-No.	Product-group
11	Cable support machine side cover small		500.0433	9010
11	Strain relief		500.0252	9010
11	Sealing cover		500.0431	9010
11	Lock ring ND 31		400.0987	9010
11	Cable support spring		500.0227	9010
11	Pan head screw M4x6	20 Pcs.	000.0552	9010
11	Screw cap 2	20 Pcs.	500.0362	9010
11	Hose 49 black Ø 3.9x1.5	40 m	109.0059	4050
11	Hose clamp Ø 7.5 mm with ring (mark 8.0)	20 Pcs.	173.0007	9010
BCS-16 compatible 7/8"-14G UNF LH				
12	BCS-16 connecting module		772.0571	2555
12	Cable support machine side small		500.0432	9010
12	Cable support machine side cover small		500.0433	9010
12	Strain relief		500.0252	9010
12	Sealing cover		500.0431	9010
12	Lock ring ND 31		400.0987	9010
12	Cable support spring		500.0227	9010
12	Pan head screw M4x6	20 Pcs.	000.0552	9010
12	Screw cap 2	20 Pcs.	500.0362	9010
12	Hose 49 black Ø 3.9x1.5	40 m	109.0059	4050
12	Hose clamp Ø 7.5 mm with ring (mark 8.0)	20 Pcs.	173.0007	9010
BCS-17 compatible BSB 10-25				
13	BCS-17 connecting module		772.0582	2555
13	Cable support machine side small		500.0432	9010
13	Cable support machine side cover small		500.0433	9010
13	Strain relief		500.0252	9010
13	Sealing cover		500.0431	9010
13	Lock ring ND 31		400.0987	9010
13	Cable support spring		500.0227	9010
13	Pan head screw M4x6	20 Pcs.	000.0552	9010
13	Screw cap 2	20 Pcs.	500.0362	9010
13	Hose clamp Ø 7.5 mm with ring (mark 8.0)	20 Pcs.	173.0007	9010
13	Hose 49 black Ø 3.9x1.5	40 m	109.0059	4050
BCS-19 compatible Oerlikon				
14	BCS-19 connecting module		772.0591	2555
14	Adaptor nut		772.0597	2005
14	Cable support machine side small		500.0432	9010
14	Cable support machine side cover small		500.0433	9010
14	Strain relief		500.0252	9010
14	Sealing cover		500.0431	9010
14	Lock ring ND 31		400.0987	9010
14	Cable support spring		500.0227	9010
14	Pan head screw M4x6	20 Pcs.	000.0552	9010
14	Screw cap 2	20 Pcs.	500.0362	9010
14	Hose clamp Ø 5.7 mm with ring (mark 6.1)	20 Pcs.	173.0008	9010
BCS-20 compatible Dalex (Gas central NW 11)				
15	BCS-20 connecting module		770.0521	2555
15	Cable support machine side small		500.0432	9010
15	Cable support machine side cover small		500.0433	9010
15	Strain relief		500.0252	9010
15	Sealing cover		500.0431	9010
15	Lock ring ND 31		400.0987	9010
15	Cable support spring		500.0227	9010
15	Pan head screw M4x6	20 Pcs.	000.0552	9010
15	Screw cap 2	20 Pcs.	500.0362	9010
15	Hose 49 black Ø 3.9x1.5	40 m	109.0059	4050







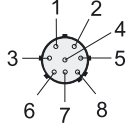
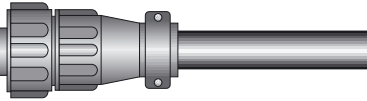
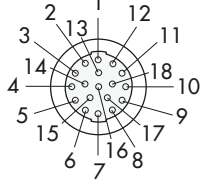
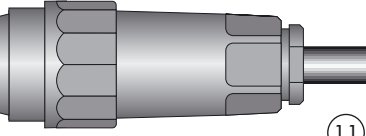
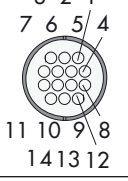
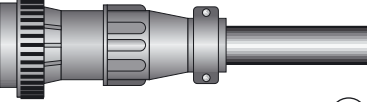
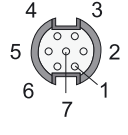
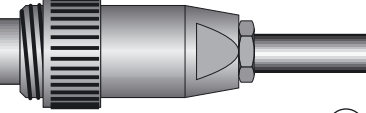
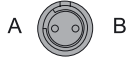
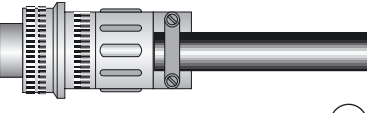
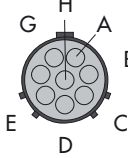
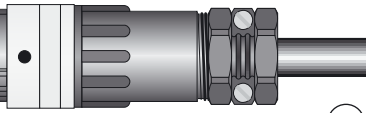

Connecting modules for ABITIG® GRIP 260 W / 450 W / 450 W SC*

Pos.	Description	Units	Part-No.	Product-group
15	Hose clamp Ø 6.2 mm with ring (mark 6.6)	20 Pcs.	173.0006	9010
15	Hose clamp Ø 7.5 mm with ring (mark 8.0)	20 Pcs.	173.0007	9010
	BCS-21 compatible Dalex (Coolant return flow central NW 11)			
16	BCS-21 connecting module		773.0531	2555
16	Cable support machine side small		500.0432	9010
16	Cable support machine side cover small		500.0433	9010
16	Strain relief		500.0252	9010
16	Sealing cover		500.0431	9010
16	Lock ring ND 31		400.0987	9010
16	Cable support spring		500.0227	9010
16	Pan head screw M4x6	20 Pcs.	000.0552	9010
16	Screw cap 2	20 Pcs.	500.0362	9010
16	Hose 49 black Ø 3.9x1.5	40 m	109.0059	4050
16	Hose 13 black Ø 4.2x1.5	100 m	109.0023	4050
16	Hose clamp Ø 7.5 mm with ring (mark 8.0)	20 Pcs.	173.0007	9010
	BCS-25 compatible Oerlikon (Gas central NW 12)			
17	BCS-25 connecting module		773.0553	2555
17	Cable support machine side small		500.0432	9010
17	Cable support machine side cover small		500.0433	9010
17	Strain relief		500.0252	9010
17	Sealing cover		500.0431	9010
17	Lock ring ND 31		400.0987	9010
17	Cable support spring		500.0227	9010
17	Pan head screw M4x6	20 Pcs.	000.0552	9010
17	Screw cap 2	20 Pcs.	500.0362	9010
17	Hose 49 black Ø 3.9x1.5	40 m	109.0059	4050
17	Hose clamp Ø 6.2 mm with ring (mark 6.6)	20 Pcs.	173.0006	9010
17	Hose clamp Ø 7.5 mm with ring (mark 8.0)	20 Pcs.	173.0007	9010
	BCS-26 compatible Lincoln BSB 35-50 (Gas central)			
18	BCS-26 connecting module		772.0515	2555
18	Cable support machine side small		500.0432	9010
18	Cable support machine side cover small		500.0433	9010
18	Strain relief		500.0252	9010
18	Sealing cover		500.0431	9010
18	Lock ring ND 31		400.0987	9010
18	Cable support spring		500.0227	9010
18	Pan head screw M4x6	20 Pcs.	000.0552	9010
18	Screw cap 2	20 Pcs.	500.0362	9010
18	Hose 49 black Ø 3.9x1.5	40 m	109.0059	4050
18	Hose clamp Ø 6.2 mm with ring (mark 6.6)	20 Pcs.	173.0006	9010
18	Hose clamp Ø 7.5 mm with ring (mark 8.0)	20 Pcs.	173.0007	9010
	BCS-33 compatible SAF (Gas central NW 12,2)			
19	BCS-33 connecting module		773.0538	2555
19	Cable support machine side small		500.0432	9010
19	Cable support machine side cover small		500.0433	9010
19	Strain relief		500.0252	9010
19	Sealing cover		500.0431	9010
19	Lock ring ND 31		400.0987	9010
19	Cable support spring		500.0227	9010
19	Pan head screw M4x6	20 Pcs.	000.0552	9010
19	Screw cap 2	20 Pcs.	500.0362	9010
19	Hose 49 black Ø 3.9x1.5	40 m	109.0059	4050
19	Hose clamp Ø 6.2 mm with ring (mark 6.6)	20 Pcs.	173.0006	9010
19	Hose clamp Ø 7.5 mm with ring (mark 8.0)	20 Pcs.	173.0007	9010
	BCS-35 compatible Kemppi (TTC Series)			
20	BCS-35 connecting module		773.0559	2555

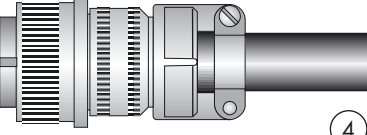
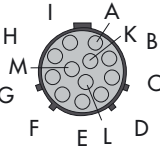
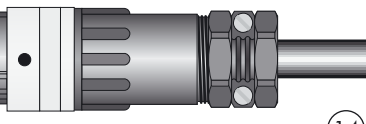
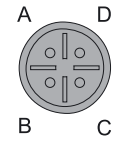
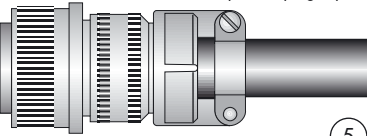

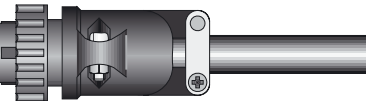
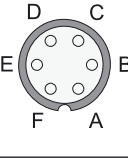
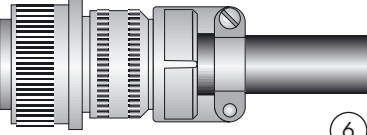
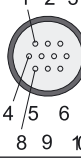
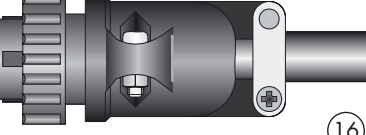
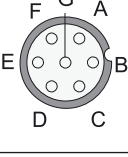
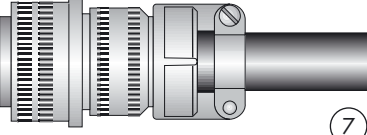
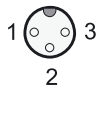

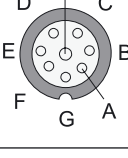
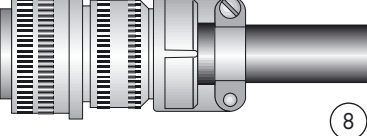
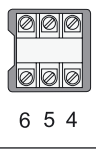
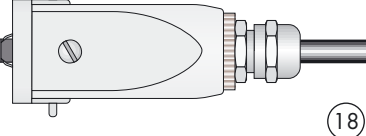
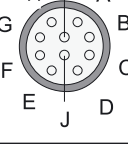
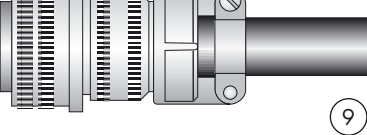
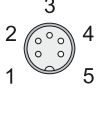
**Control line plugs *BLS*
adaptable for all common
TIG Welding power sources**

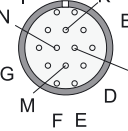
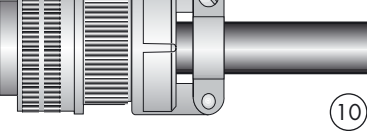
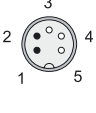
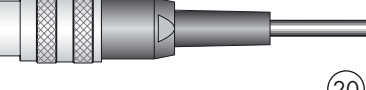

Control line plugs

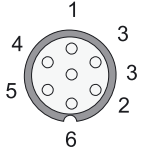
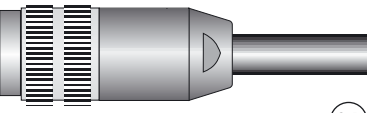
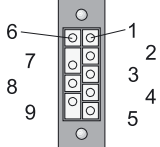
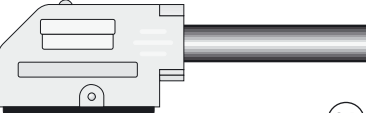
	<p>AMP plug 8-pole cpl.</p>  <p>①</p>		<p>Amphenol plug 18-pole cpl.</p>  <p>⑪</p>
	<p>AMP plug 14-pole cpl.</p>  <p>②</p>		<p>Binder plug 7-pole</p>  <p>⑫</p>
	<p>Amphenol plug 2-pole</p>  <p>③</p>		<p>Burndy plug 8-pole cpl.</p>  <p>⑬</p>
	<p>Amphenol plug 2-pole</p>  <p>④</p>		<p>Burndy plug 12-pole cpl.</p>  <p>⑭</p>
	<p>Amphenol plug 4-pole</p>  <p>⑤</p>		<p>DDK plug 5-pole</p>  <p>⑮</p>
	<p>Amphenol plug 6-pole</p>  <p>⑥</p>		<p>DDK plug 10-pole</p>  <p>⑯</p>
	<p>Amphenol plug 7-pole (Z-version)</p>  <p>⑦</p>		<p>Dioden plug 3-pole</p>  <p>⑰</p>
	<p>Amphenol plug 8-pole</p>  <p>⑧</p>		<p>Haring plug 6-pole</p>  <p>⑱</p>
	<p>Amphenol plug 10-pole</p>  <p>⑨</p>		<p>Cable plug 5-pole</p>  <p>⑲</p>
	<p>Amphenol plug 14-pole</p>  <p>⑩</p>		<p>Cable plug 5-pole</p>  <p>⑳</p>

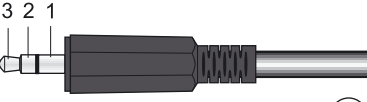
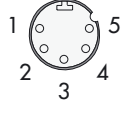
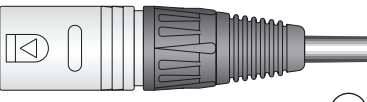
Control line plugs

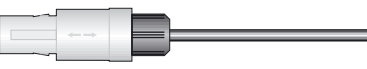
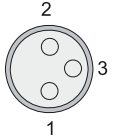
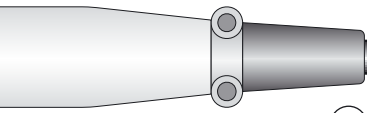
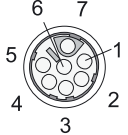
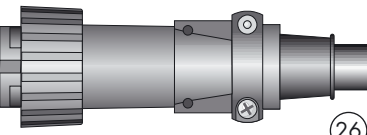
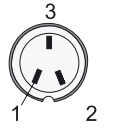
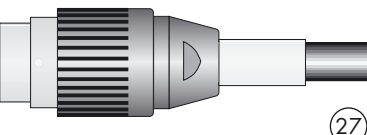
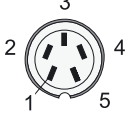
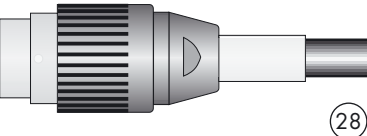
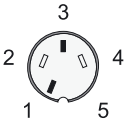
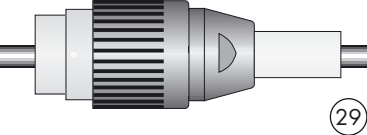
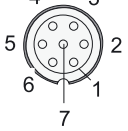
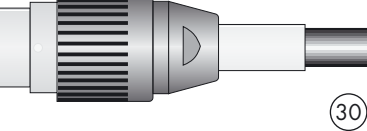
	<p>Cable plug 7-pole</p>  <p>(21)</p>		<p>Tüchel plug 9-pole</p>  <p>(31)</p>
	<p>Klinken plug 3-pole</p>  <p>(22)</p>		
	<p>Neutrik plug 5-pole</p>  <p>(23)</p>		
	<p>Redel plug 2-pole</p>  <p>(24)</p>		
	<p>Round plug connector 3-pole</p>  <p>(25)</p>		
	<p>Plug 7-pole</p>  <p>(26)</p>		
	<p>Tüchel plug 3-pole</p>  <p>(27)</p>		
	<p>Tüchel plug 5-pole</p>  <p>(28)</p>		
	<p>Tüchel plug 5-pole (screwed)</p>  <p>(29)</p>		
	<p>Tüchel plug 7-pole</p>  <p>(30)</p>		

Notes

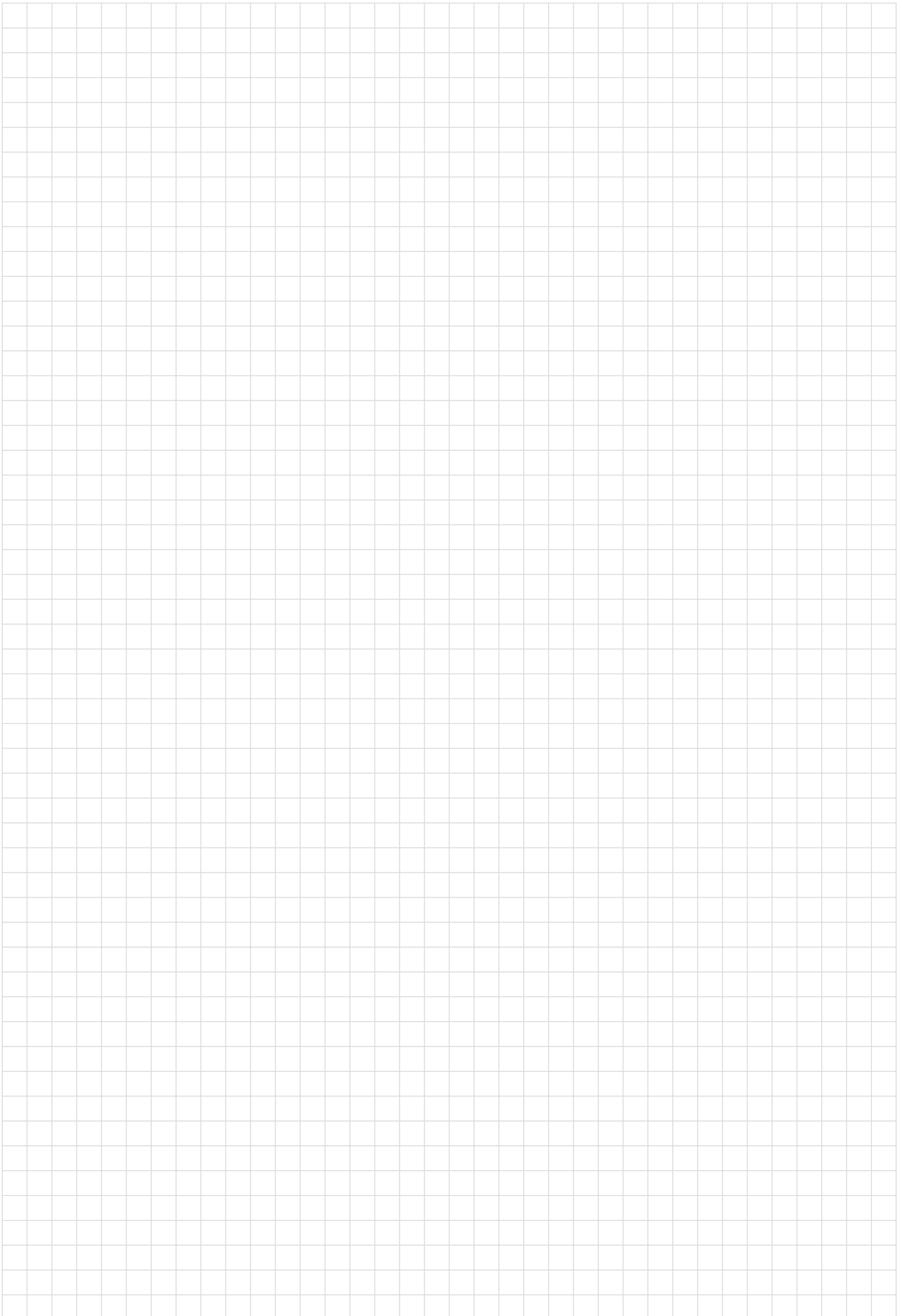

**Hose connection
components *BHC*
machine-side connections
air and liquid cooled**



TIG Welding Torches

ABITIG® with rotary valve air cooled

- Rotary valve for regulating gas directly on the torch body
- Light and flexible cable assemblies for all salable TIG Welding power sources
- Consumables compatible to the international standard



Technical data
(EN 60 974-7)

TIG Welding Torches "ABITIG®" with rotary valve (air cooled)

Type	Rating (A)		Duty cycle (%)	Tungsten electrode-Ø (mm)
	DC	AC		
ABITIG® 9 V	110	80	35	0.5 - 1.6
ABITIG® 17 V / 17 FV	140	100	35	0.5 - 2.4
ABITIG® 26 V / 26 FV	180	130	35	0.5 - 4.0

F=Flexible. Subject to change without notice.

TIG Welding Torches ABITIG® 9 V / 17 V / 17 FV with rotary valve

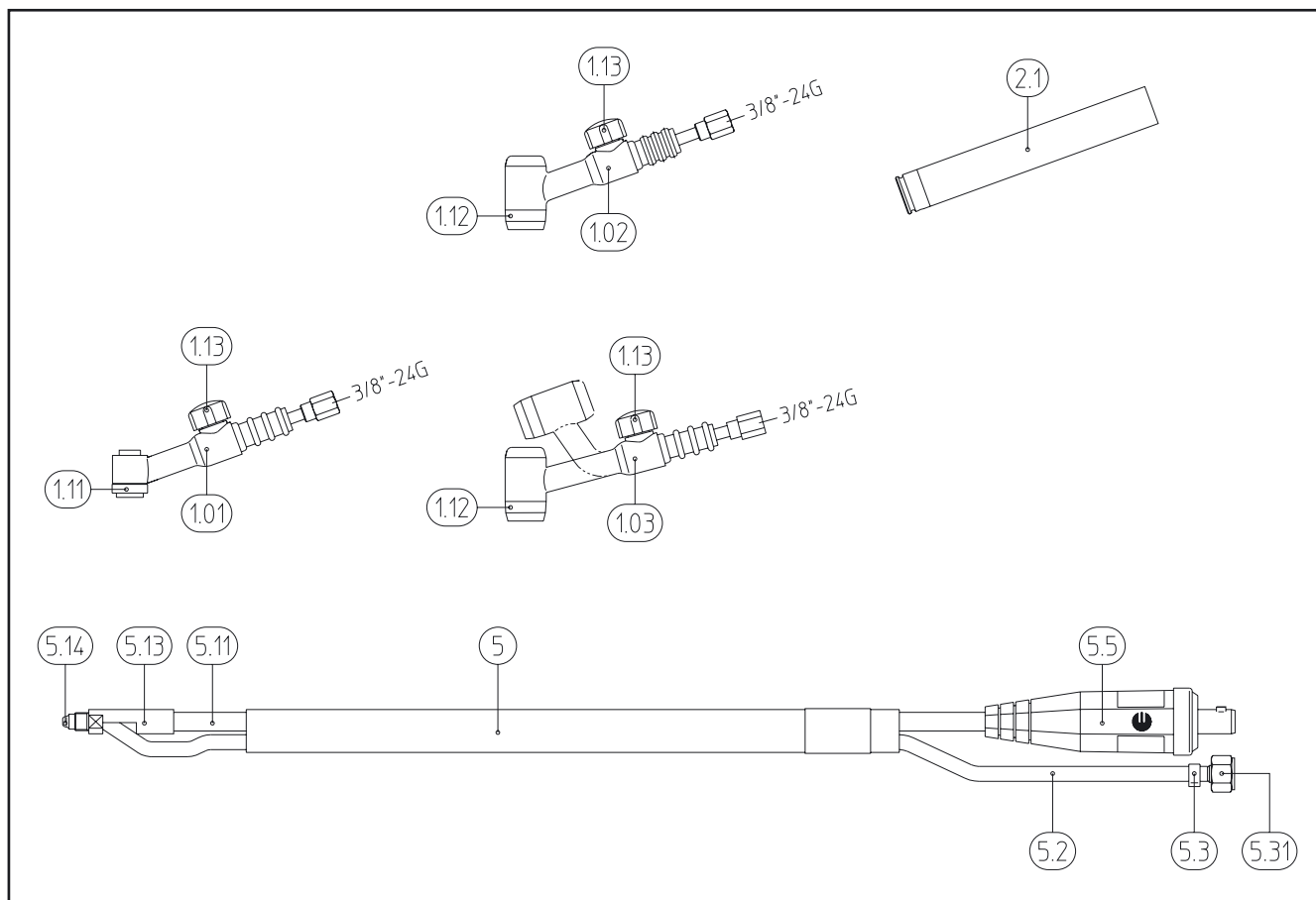

Pos.	Description	Units	Part-No.	Product-group
Torch				
	ABITIG® 9 V; with valve; plug 10-25; 4.00 m long		706.5057	2012
	ABITIG® 9 V; with valve; plug 10-25; 8.00 m long		706.5058	2012
	ABITIG® 17 V; with valve; plug 10-25; 4.00 m long		706.1057	2012
	ABITIG® 17 V; with valve; plug 10-25; 8.00 m long		706.1058	2012
	ABITIG® 17 V; with valve; plug 35-50; 4.00 m long		706.1037	2012
	ABITIG® 17 V; with valve; plug 35-50; 8.00 m long		706.1038	2012
	ABITIG® 17 FV; with valve; plug 10-25; 4.00 m long		706.1157	2012
	ABITIG® 17 FV; with valve; plug 10-25; 8.00 m long		706.1158	2012
	ABITIG® 17 FV; with valve; plug 35-50; 4.00 m long		706.1137	2012
	ABITIG® 17 FV; with valve; plug 35-50; 8.00 m long		706.1138	2012
Torch body				
1.01	Torch body ABITIG® 9 V; 60.0 mm long		705.0007	2002
1.02	Torch body ABITIG® 17 V; 65.0 mm long		705.0038	2002
1.03	Torch body ABITIG® 17 FV (flexible); 80.0 mm long		703.0010	2002
1.11	Insulating ring	10 Pcs.	702.0055	2003
1.12	Insulating ring	10 Pcs.	703.0012	2003
1.13	Valve ABITIG® 9 V / 17 V / 17 FV		705.0046	2005
Handle				
2.1	Handle tube ABITIG® 9 V / ABITIG® 17 V / ABITIG® 17 FV		705.1440	2005
Cable assembly				
5	Outer cover rubber Ø 20x1.5	40 m	105.0005	4050
5.11	Power cable type 16 for 4.00 m		118.0042	2005
5.11	Power cable type 16 for 8.00 m		118.0043	2005
5.13	Hose connector for 3/8"-24G		717.0015	2005
5.14	Powerfitting 3/8"-24G		717.0014	2005
5.2	Hose Ø 3x1.5	100 m	102.0124	4050
5.3	Hose clamp Ø 7.5 mm with ring (mark 8.0)	20 Pcs.	173.0007	9010

TIG Welding Torches ABITIG® 26 V / 26 FV with rotary valve

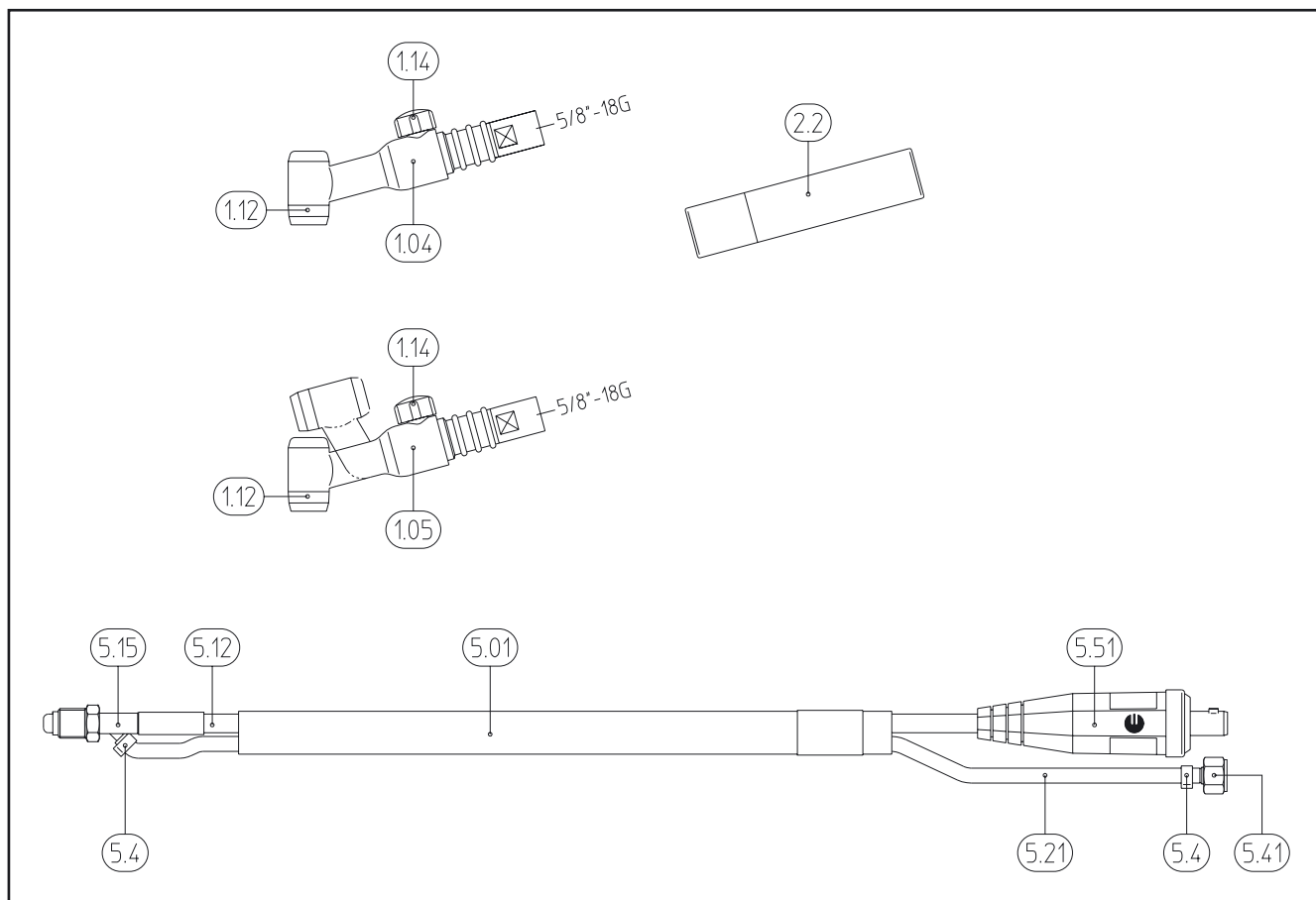

Pos.	Description	Units	Part-No.	Product-group
Torch				
	ABITIG® 26 V; with valve; plug 35-50; 4.00 m long		706.4037	2012
	ABITIG® 26 V; with valve; plug 35-50; 8.00 m long		706.4038	2012
	ABITIG® 26 FV; with valve; plug 35-50; 4.00 m long		706.4137	2012
	ABITIG® 26 FV; with valve; plug 35-50; 8.00 m long		706.4138	2012
Torch body				
1.04	Torch body ABITIG® 26 V; 80.0 mm long		705.0091	2002
1.05	Torch body ABITIG® 26 FV (flexible); 80.0 mm long		703.0290	2002
1.12	Insulating ring	10 Pcs.	703.0012	2003
1.14	Valve ABITIG® 26 V / 26 FV		705.0097	2005
Handle				
2.2	Handle tube		705.0096	2005
Cable assembly				
5.01	Outer cover rubber Ø 25x1.25	40 m	105.0019	4050
5.12	Power cable type 35 for 4.00 m; with welding cable plug ABI-CM 35-50		118.0019	2005
5.12	Power cable type 35 for 8.00 m; with welding cable plug ABI-CM 35-50		118.0021	2005
5.15	Cable support 5/8"-18G		726.0002	2005
5.21	Hose 30 black Ø 4.9x1.5	100 m	109.0040	4050
5.4	Hose clamp Ø 9.0 mm with ring (mark 9.5)	20 Pcs.	173.0001	9010
5.41	Coupling nut G 1/4"	10 Pcs.	500.0082	9010
5.41	Hose connector G 1/4"	10 Pcs.	500.0087	9010
5.51	Welding cable plug ABI-CM 35-50		511.0315	4002

TIG Automatic Welding Torches

ABITIG®-MT

air and liquid cooled

- Compact design
- Light and flexible cable assemblies for all common TIG Welding power sources
- ABITIG® 200 MT / 300 W MT with pre-adjustable tungsten electrode
- Especially suitable for welds at components with simple geometries

ABITIG® 150 MT

ABITIG® 300 W MT

■ Adjustable tungsten electrode

Technical data
(EN 60 974-7)

TIG Automatic Welding Torches "ABITIG®-MT" (air and liquid cooled)

Type	Cooling	Rating (A)		Duty cycle (%)	Tungsten electrode-Ø (mm)
		DC	AC		
ABITIG® 150 MT	air cooled	150	110	60	1.0 - 3.2
ABITIG® 200 MT	air cooled	200	140	60	1.6 - 4.0
ABITIG® 260 W MT	liquid cooled	260	180	100	1.0 - 3.2
ABITIG® 300 W MT	liquid cooled	300	210	100	1.6 - 4.8
ABITIG® 400 W MT	liquid cooled	400	280	100	1.6 - 4.8
ABITIG® 500 W MT	liquid cooled	500	350	100	1.6 - 6.4

Subject to change without notice.

TIG Automatic Welding Torches ABITIG® 150 MT

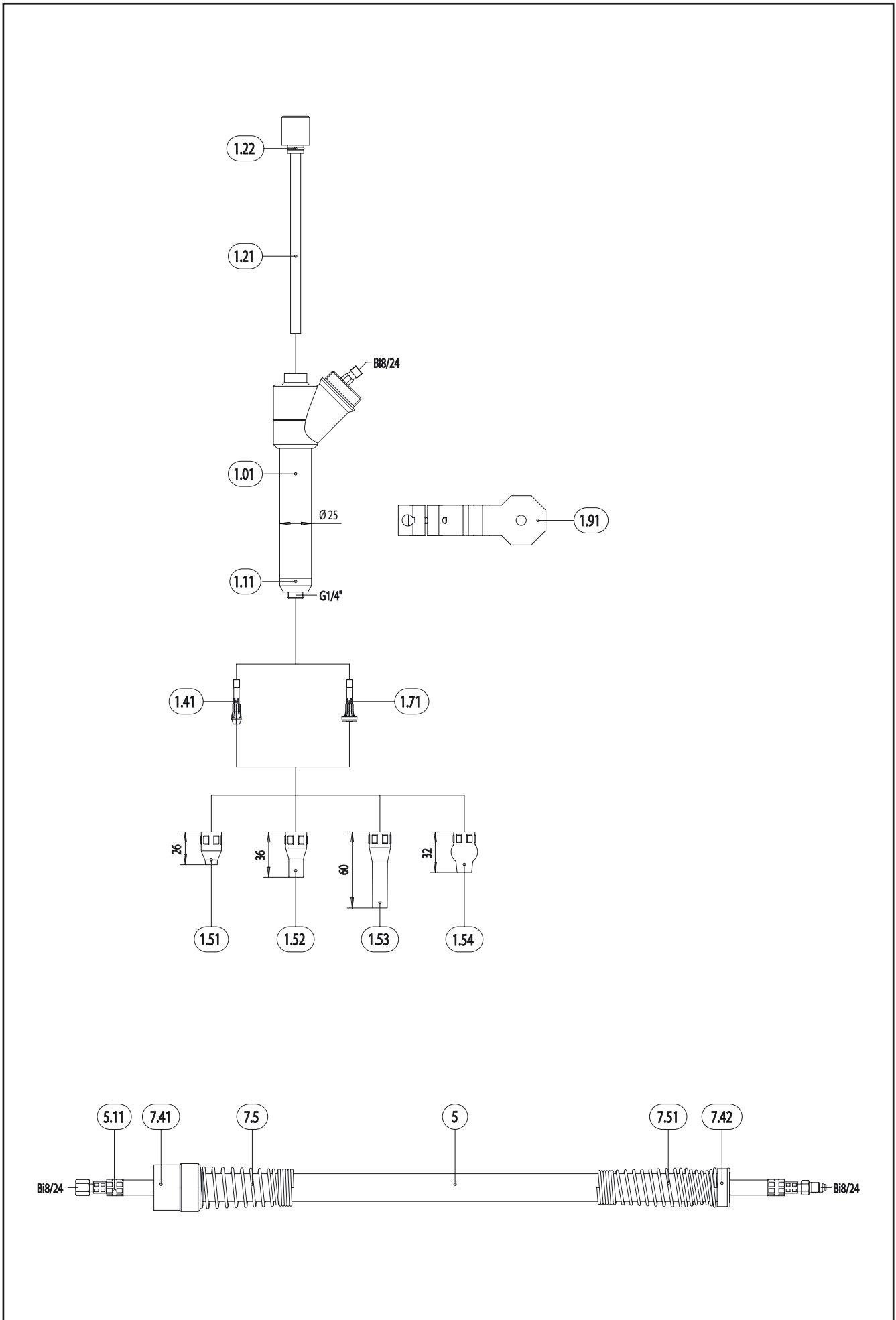

TIG Automatic Welding Torches ABITIG® 200 MT

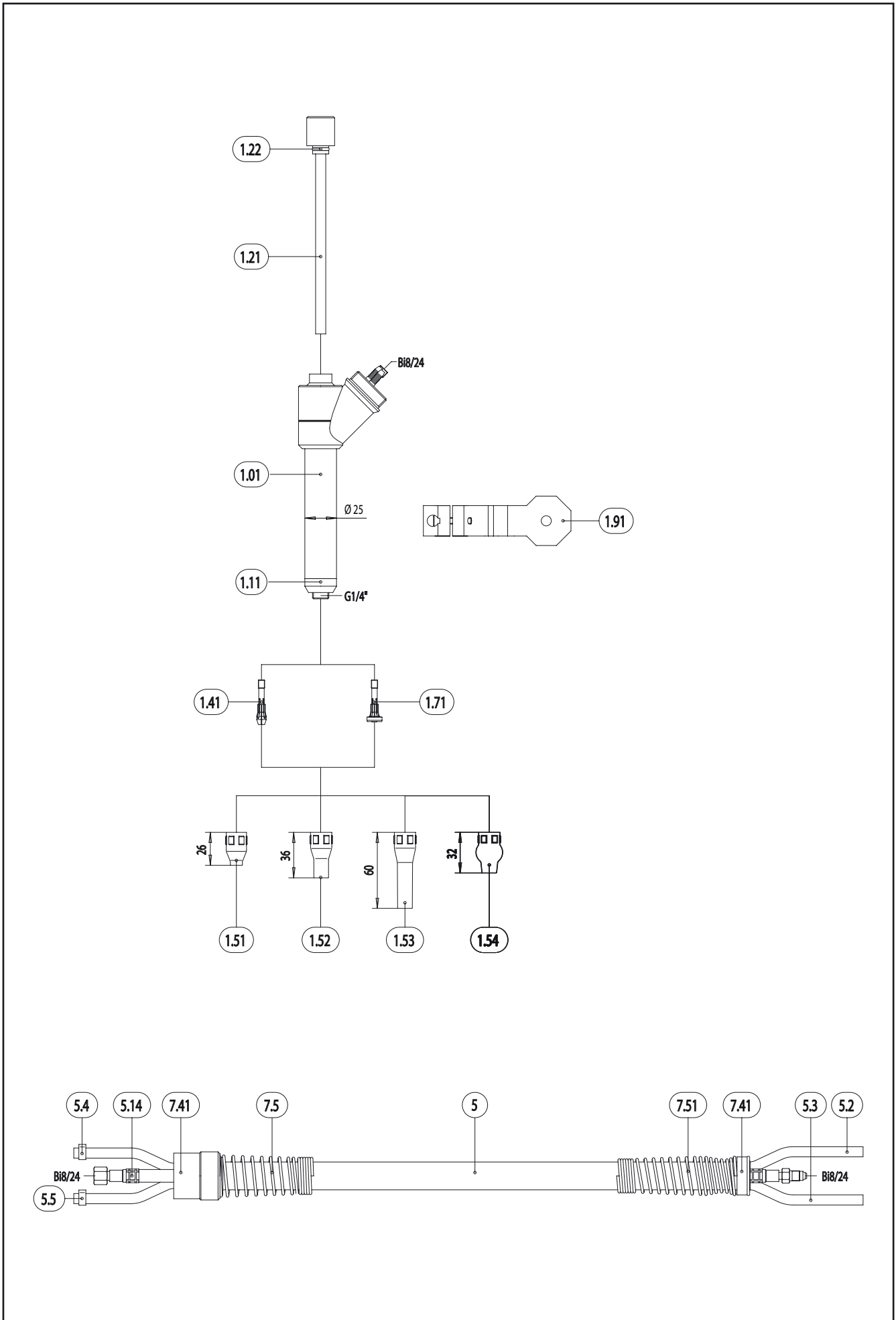

TIG Automatic Welding Torches ABITIG® 200 MT

Pos.	Description	Units	Part-No.	Product-group
Torch body				
1.01	Torch body ABITIG® 200 MT		778.2020	2532
1.11	Insulator		775.1043	2555
1.12	Insulator for gas diffusor 4		775.1143	2555
1.21	Guide tube cpl. ABITIG® 200 MT / ABITIG® 300 W MT		778.1030	2555
1.22	O-Ring 13.46x2.08	20 Pcs.	165.0079	9010
1.23	Collet		778.1140	2555
Wear parts				
1.42	Electrode holder for electrode WE Ø 1.6 mm	5 Pcs.	775.0062	2548
1.42	Electrode holder for electrode WE Ø 2.4 mm	5 Pcs.	775.0063	2548
1.42	Electrode holder for electrode WE Ø 3.2 mm	5 Pcs.	775.0064	2548
1.42	Electrode holder for electrode WE Ø 4.0 mm	5 Pcs.	775.0065	2548
1.42	Electrode holder for electrode WE Ø 4.8 mm	5 Pcs.	775.0066	2548
1.53	Ceramic gas nozzle 37.4 mm; ND 7.5 mm	10 Pcs.	775.0081	2541
1.53	Ceramic gas nozzle 37.4 mm; ND 10.5 mm	10 Pcs.	775.0082	2541
1.53	Ceramic gas nozzle 37.4 mm; ND 13.0 mm	10 Pcs.	775.0083	2541
1.53	Ceramic gas nozzle 37.4 mm; ND 15.0 mm	10 Pcs.	775.0084	2541
1.54	Ceramic gas nozzle 51.5 mm; ND 7.5 mm	10 Pcs.	775.2171	2541
1.54	Ceramic gas nozzle 51.5 mm; ND 10.0 mm	10 Pcs.	775.2172	2541
1.54	Ceramic gas nozzle 51.5 mm; ND 13.0 mm	10 Pcs.	775.2173	2541
1.54	Ceramic gas nozzle 51.5 mm; ND 16.0 mm	10 Pcs.	775.2174	2541
1.55	Ceramic gas nozzle 38.4 mm; ND 13.0 mm (reenforced)	10 Pcs.	775.0183	2541
1.55	Ceramic gas nozzle 38.4 mm; ND 15.0 mm (reenforced)	10 Pcs.	775.0184	2541
1.72	Gas diffuser for electrode WE-Ø 1.0 mm		773.0171	2548
1.72	Gas diffuser for electrode WE-Ø 1.6 mm		773.0172	2548
1.72	Gas diffuser for electrode WE-Ø 2.4 mm		773.0173	2548
1.72	Gas diffuser for electrode WE-Ø 3.2 mm		773.0174	2548
1.72	Gas diffuser for electrode WE-Ø 4.0 mm		773.0175	2548
1.72	Gas diffuser for electrode WE-Ø 4.8 mm		773.0176	2548
1.73	Adaptor part WE-Ø 1.6 mm		778.1142	2555
1.73	Adaptor part WE-Ø 2.4 mm		778.1143	2555
1.73	Adaptor part WE-Ø 3.2 mm		778.1144	2555
1.73	Adaptor part WE-Ø 4.0 mm		778.1145	2555
1.73	Adaptor part WE-Ø 4.8 mm		778.1146	2555
1.74	Gas diffuser 4-MT for electrode WE-Ø 1.6 - 4.8 mm		778.1148	2548
w/o. fig.	Sieve		778.1109	2555
w/o. fig.	Retaining ring		775.0108	2555
1.75	Ceramic adaptor		778.1185	2541
1.81	Ceramic gas nozzle 50 mm; ND 12.5 mm	10 Pcs.	778.1183	2541
1.81	Ceramic gas nozzle 50 mm; ND 16.0 mm	10 Pcs.	778.1184	2541
1.81	Ceramic gas nozzle 50 mm; ND 19.5 mm	10 Pcs.	778.1188	2541
1.82	Ceramic gas nozzle 34 mm; ND 24.0 mm	10 Pcs.	778.1189	2541
1.84	Gas nozzle metal 48 mm; ND 16.0 mm		778.1186	2541
1.84	Gas nozzle metal 48 mm; ND 19.0 mm		778.1187	2541
Accessories				
1.9	Alignment jig ABITIG® MT		778.1157	2555
1.91	Torch mount MT-26		780.0258	5207
1.91	Torch mount MT-30		780.0145	5207
Cable assembly				
5	Hose 9 black Ø 18.2x1.25	60 m	109.0019	4050
5.11	Power cable High Flex (ABITIG® MT) for 4.00 m		150.0175	2555
7.41	Strain relief ERGO		400.0412	9010
7.42	Strain relief		500.0252	9010
7.5	Cable support spring		775.1341	2555
7.51	Cable support spring		500.0226	9010

TIG Automatic Welding Torches ABITIG® 300 W MT

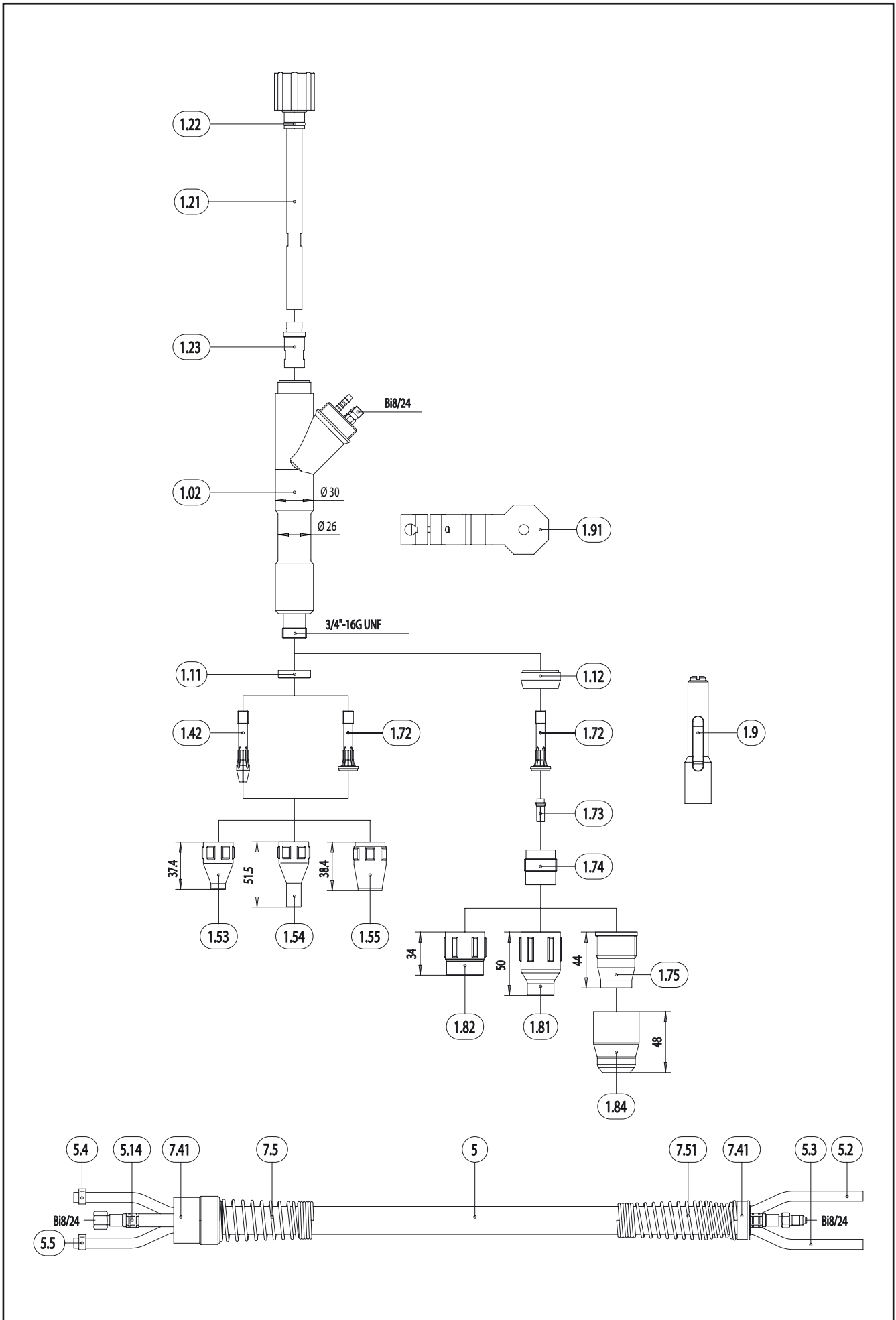

TIG Automatic Welding Torches ABITIG® 300 W MT

Pos.	Description	Units	Part-No.	Product-group
Torch body				
1.02	Torch body ABITIG® 300 W MT		779.2020	2532
1.11	Insulator		775.1043	2555
1.12	Insulator for gas diffusor 4		775.1143	2555
1.21	Guide tube cpl. ABITIG® 200 MT / ABITIG® 300 W MT		778.1030	2555
1.22	O-Ring 13.46x2.08	20 Pcs.	165.0079	9010
1.23	Collet		778.1140	2555
Wear parts				
1.42	Electrode holder for electrode WE Ø 1.6 mm	5 Pcs.	775.0062	2548
1.42	Electrode holder for electrode WE Ø 2.4 mm	5 Pcs.	775.0063	2548
1.42	Electrode holder for electrode WE Ø 3.2 mm	5 Pcs.	775.0064	2548
1.42	Electrode holder for electrode WE Ø 4.0 mm	5 Pcs.	775.0065	2548
1.42	Electrode holder for electrode WE Ø 4.8 mm	5 Pcs.	775.0066	2548
1.53	Ceramic gas nozzle 37.4 mm; ND 7.5 mm	10 Pcs.	775.0081	2541
1.53	Ceramic gas nozzle 37.4 mm; ND 10.5 mm	10 Pcs.	775.0082	2541
1.53	Ceramic gas nozzle 37.4 mm; ND 13.0 mm	10 Pcs.	775.0083	2541
1.53	Ceramic gas nozzle 37.4 mm; ND 15.0 mm	10 Pcs.	775.0084	2541
1.54	Ceramic gas nozzle 51.5 mm; ND 7.5 mm	10 Pcs.	775.2171	2541
1.54	Ceramic gas nozzle 51.5 mm; ND 10.0 mm	10 Pcs.	775.2172	2541
1.54	Ceramic gas nozzle 51.5 mm; ND 13.0 mm	10 Pcs.	775.2173	2541
1.54	Ceramic gas nozzle 51.5 mm; ND 16.0 mm	10 Pcs.	775.2174	2541
1.55	Ceramic gas nozzle 38.4 mm; ND 13.0 mm (reenforced)	10 Pcs.	775.0183	2541
1.55	Ceramic gas nozzle 38.4 mm; ND 15.0 mm (reenforced)	10 Pcs.	775.0184	2541
1.72	Gas diffuser for electrode WE-Ø 1.0 mm		773.0171	2548
1.72	Gas diffuser for electrode WE-Ø 1.6 mm		773.0172	2548
1.72	Gas diffuser for electrode WE-Ø 2.4 mm		773.0173	2548
1.72	Gas diffuser for electrode WE-Ø 3.2 mm		773.0174	2548
1.72	Gas diffuser for electrode WE-Ø 4.0 mm		773.0175	2548
1.72	Gas diffuser for electrode WE-Ø 4.8 mm		773.0176	2548
1.73	Adaptor part WE-Ø 1.6 mm		778.1142	2555
1.73	Adaptor part WE-Ø 2.4 mm		778.1143	2555
1.73	Adaptor part WE-Ø 3.2 mm		778.1144	2555
1.73	Adaptor part WE-Ø 4.0 mm		778.1145	2555
1.73	Adaptor part WE-Ø 4.8 mm		778.1146	2555
1.74	Gas diffuser 4-MT for electrode WE-Ø 1.6 - 4.8 mm		778.1148	2548
w/o. fig.	Sieve		778.1109	2555
w/o. fig.	Retaining ring		775.0108	2555
1.75	Ceramic adaptor		778.1185	2541
1.81	Ceramic gas nozzle 50 mm; ND 12.5 mm	10 Pcs.	778.1183	2541
1.81	Ceramic gas nozzle 50 mm; ND 16.0 mm	10 Pcs.	778.1184	2541
1.81	Ceramic gas nozzle 50 mm; ND 19.5 mm	10 Pcs.	778.1188	2541
1.82	Ceramic gas nozzle 34 mm; ND 24.0 mm	10 Pcs.	778.1189	2541
1.84	Gas nozzle metal 48 mm; ND 16.0 mm		778.1186	2541
1.84	Gas nozzle metal 48 mm; ND 19.0 mm		778.1187	2541
Accessories				
1.9	Alignment jig ABITIG® MT		778.1157	2555
1.91	Torch mount MT-26		780.0258	5207
1.91	Torch mount MT-30		780.0145	5207
Cable assembly				
5	Hose 10 black Ø 22x1.25	40 m	109.0020	4050
5.14	Power cable High Flex (ABITIG® MT) for 4.00 m		150.0175	2555
5.2	Hose Ø 3x1.5	100 m	102.0124	4050
5.3	Hose 49 black Ø 3.9x1.5	40 m	109.0059	4050
5.4	Hose clamp Ø 6.2 mm with ring (mark 6.6)	20 Pcs.	173.0006	9010
5.5	Hose clamp Ø 7.5 mm with ring (mark 8.0)	20 Pcs.	173.0007	9010
7.41	Strain relief		400.0413	9010

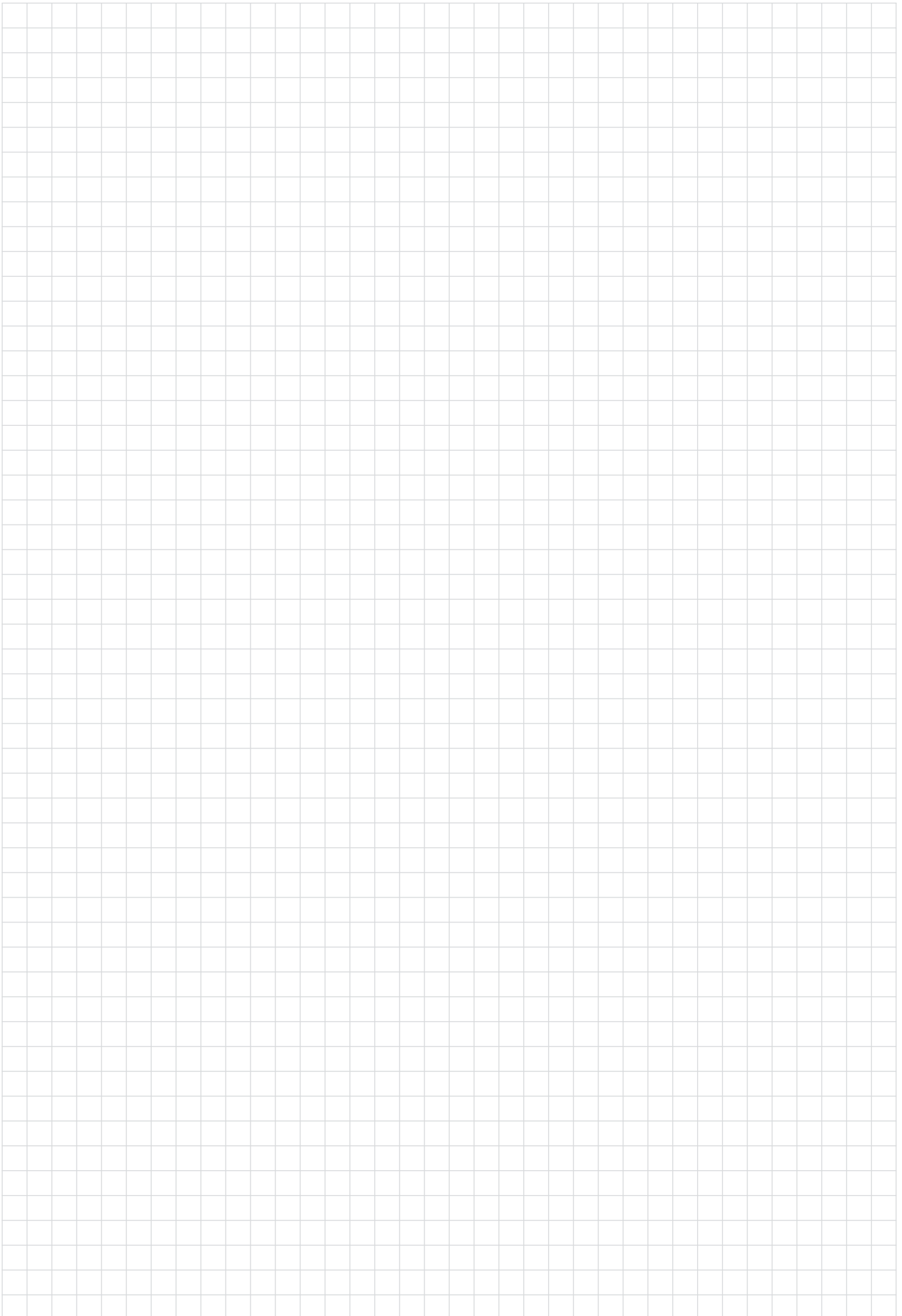

TIG Automatic Welding Torches ABITIG® 400 W MT

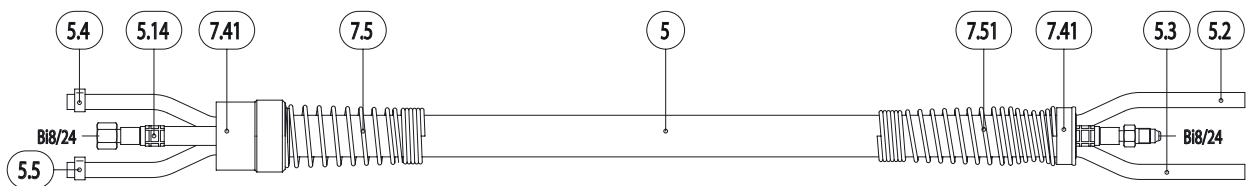
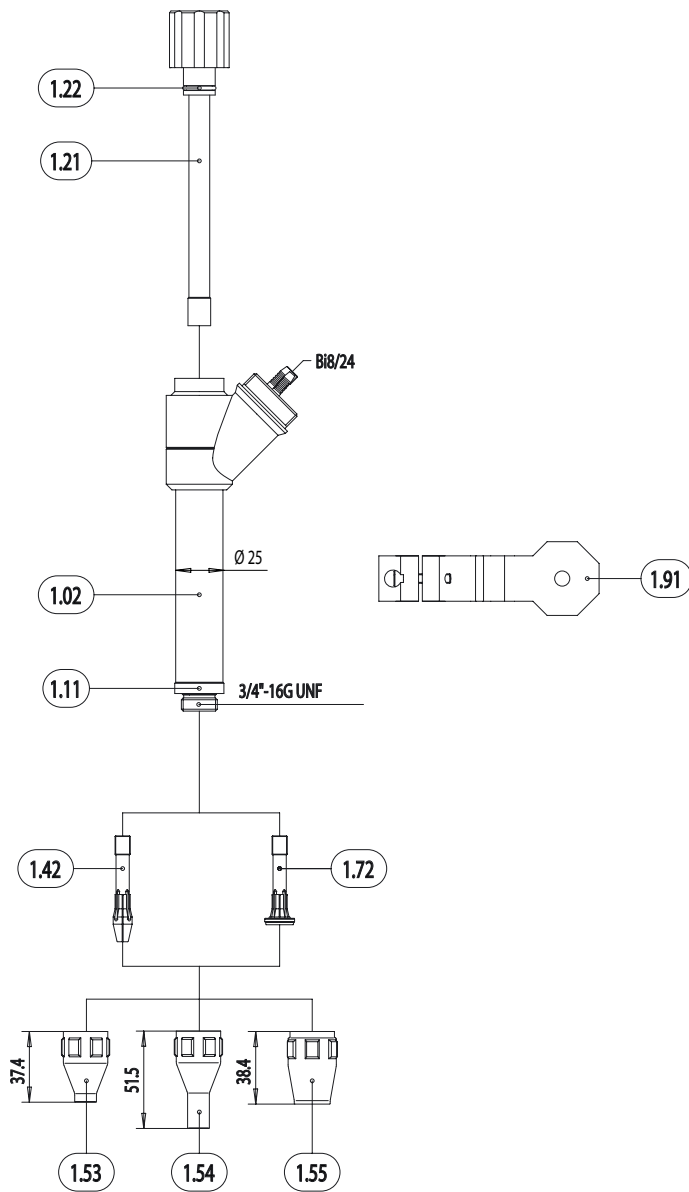

TIG Automatic Welding Torches ABITIG® 500 W MT

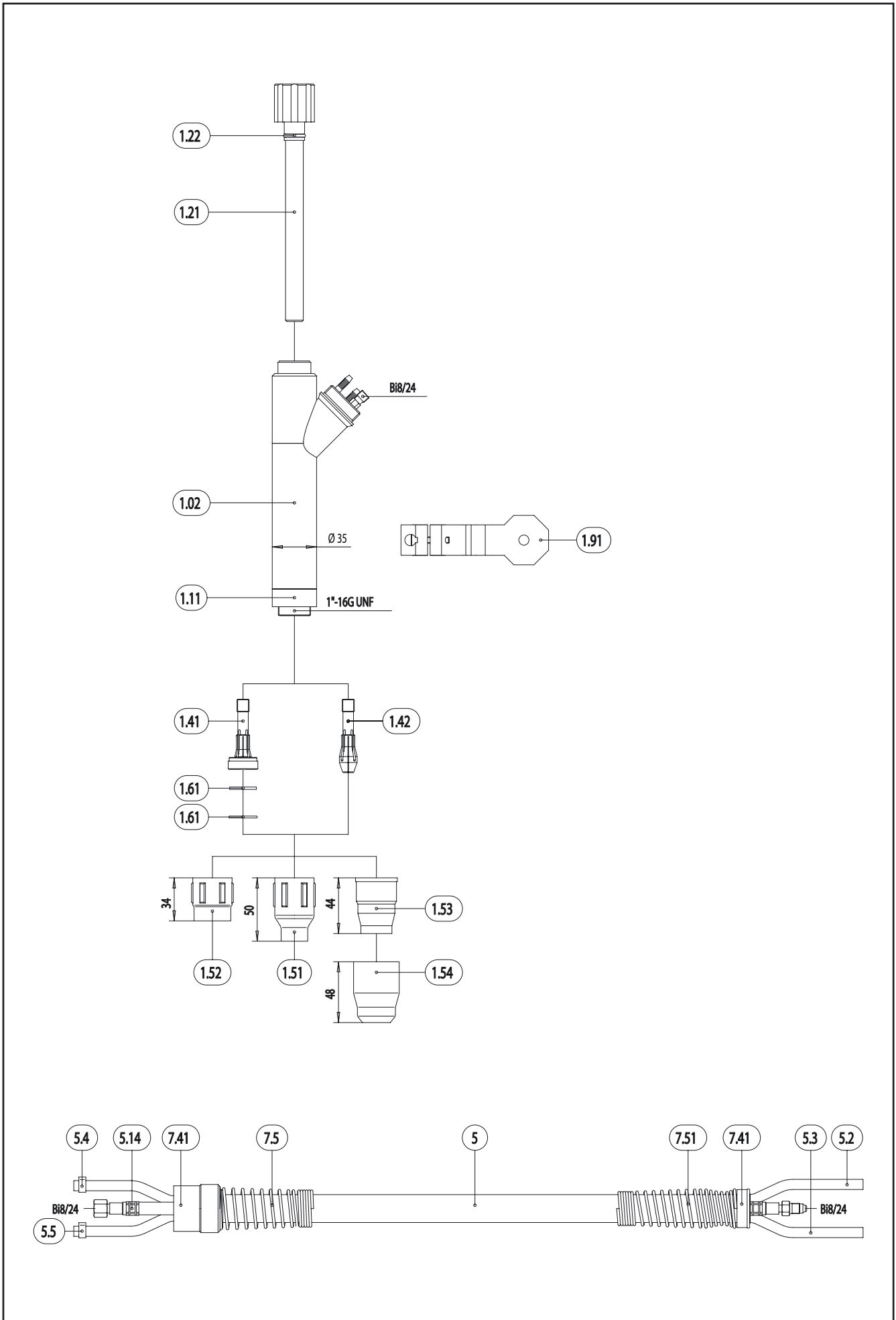

Notes

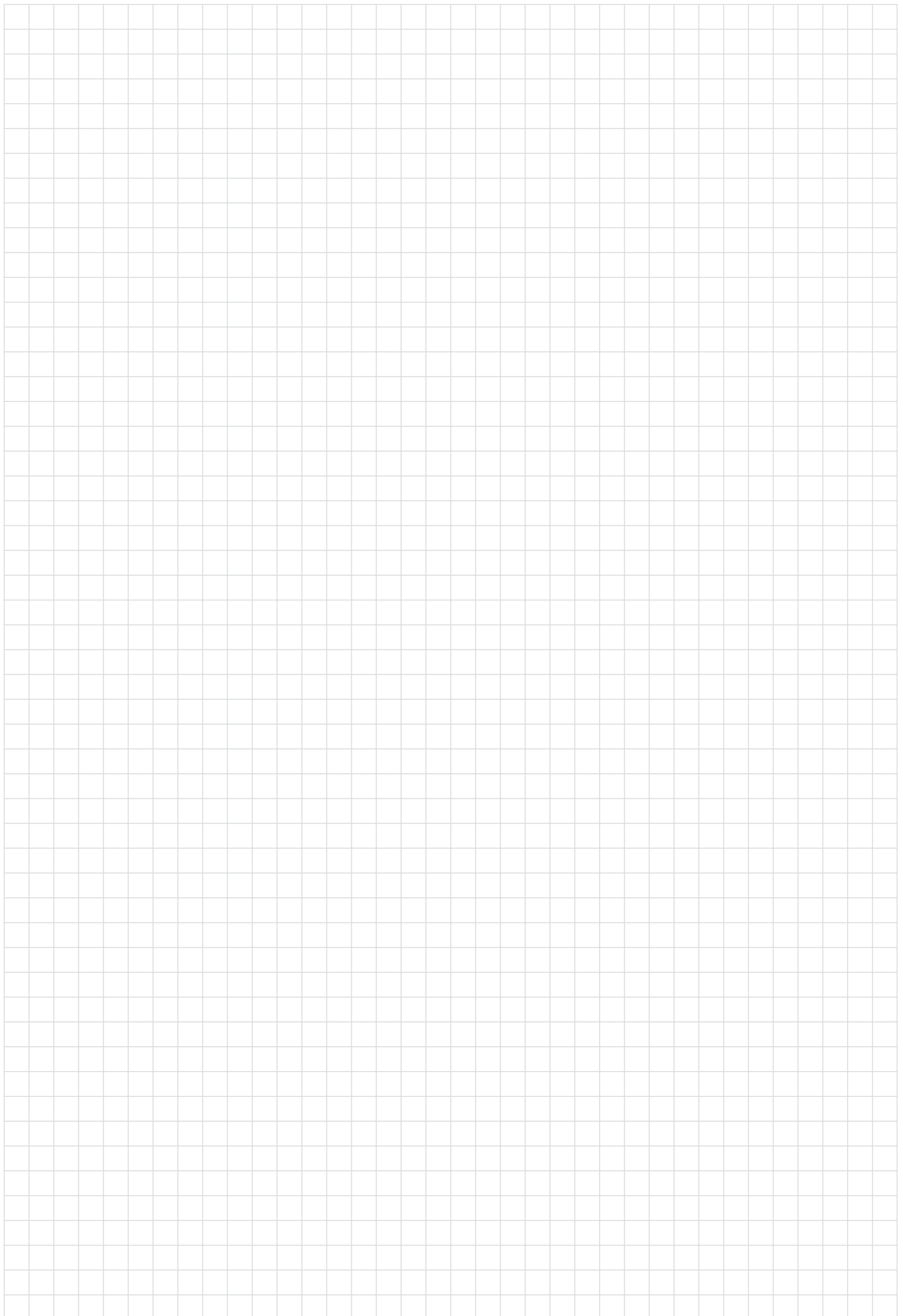

Cold Wire Feeder System ABIDRIVE-CW and ABITIG® GRIP Welding Torches with cold wire feed air and liquid cooled The right "Drive" ...

The ABIDRIVE-CW cold wire feeding system – especially developed for the industrial use – cares for optimal and constant wire feeding. To utilize for hand operated and automated TIG cold wire welding.

Due to the customized intermediate cable assemblies the ABIDRIVE-CW wire feeding system is easy to adapt to several air and liquid cooled TIG power sources without any difficulty.

The ABICOR BINZEL® welding torches from the ABITIG® series with cold wire feed and integrated control module inside the handle will complete the system.

- Selective 2- or 4-T mode
- Interval mode
- Free selection of welding and brake times
- Feeding speed 0–10 m/min.
- Four roll drive (toothed)
- Soft start

Technical data (IEC 60974)

Cold Wire Feeder System "ABIDRIVE-CW"

Feeding unit

Weight:	19 kg
Measurements (LxWxH):	approx. 580x280x380 mm
Wire feeding speed:	0–10 m/min.
Standard drive rolls:	0.8–1.2 mm

Power supply

Weight:	7.5 kg
Measurements (LxWxH):	approx. 185 x 200 x 175 mm
Inlet voltage:	230V / 50 Hz
Power consumption:	40 W / 28 V
Power input:	0.15 kVA
Interval frequency:	approx. 0.5 Hz
Protection class:	IP 21

The technical data of the ABITIG® GRIP Welding Torches with cold wire feed correspond with the technical data of the ABITIG® GRIP Torch series in chapter 2.

Cold Wire Feeder System ABIDRIVE-CW

System overview direct connection ABIDRIVE-CW

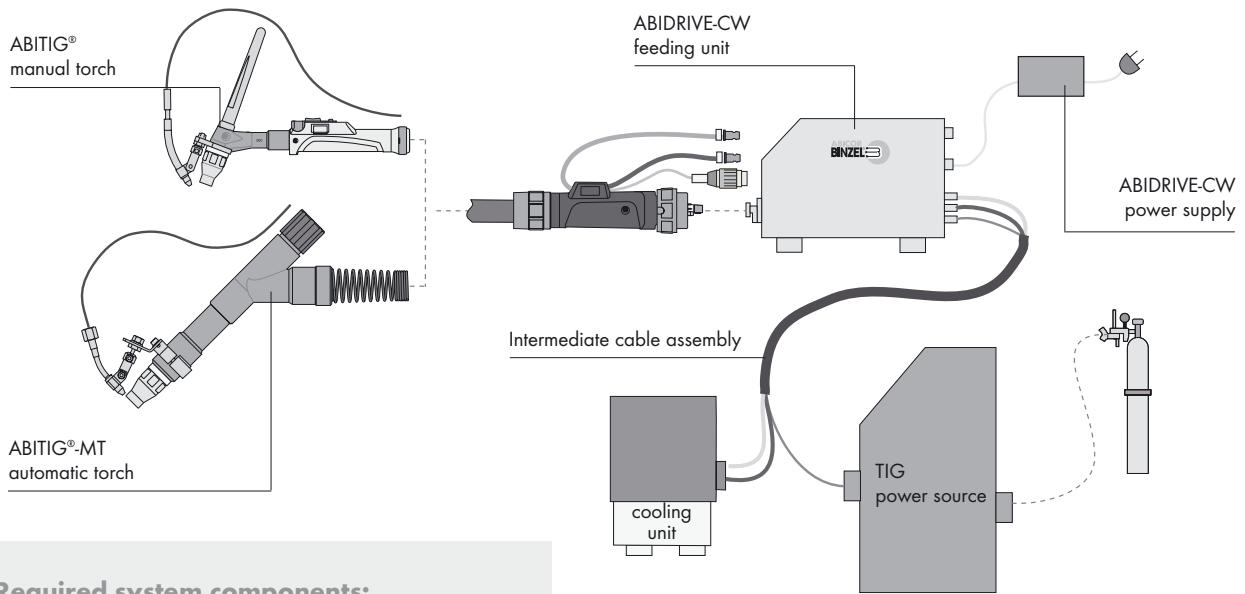

Required system components:

- ABIDRIVE-CW cpl.
- ABITIG® Welding Torch
- Intermediate cable assembly

System overview direct connection power source

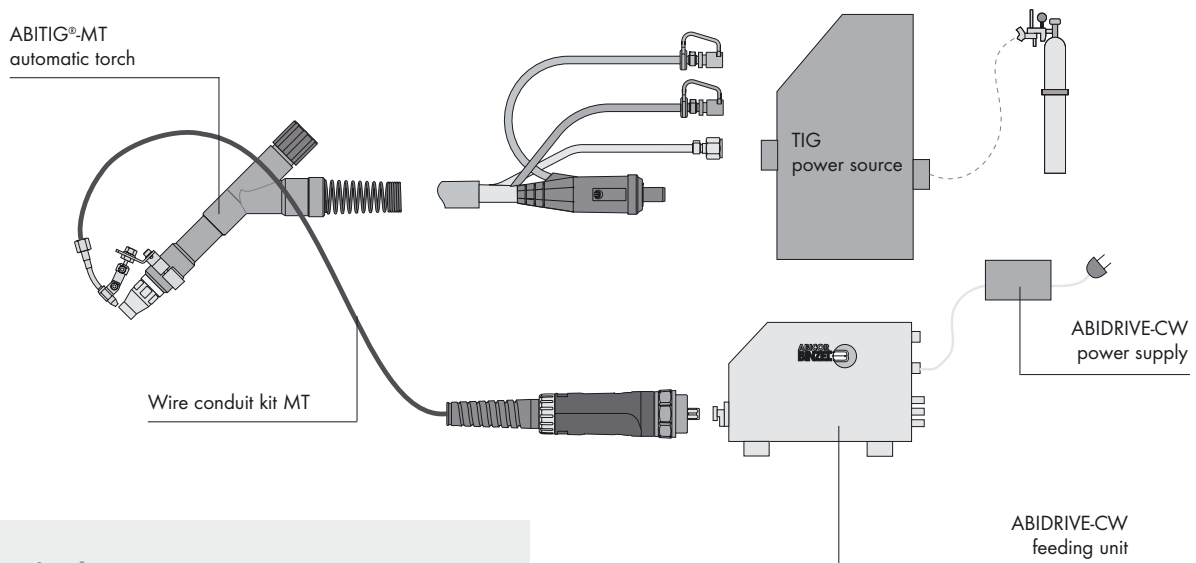

Required system components:

- ABIDRIVE-CW cpl.
- ABITIG® MT Welding Torch
- Cold wire feed MT cpl.

Cold Wire Feeder System ABIDRIVE-CW



Pos.	Description	Units	Part-No.	Product-group
	Cold wire feeder system ABIDRIVE-CW			
1	Cold wire feeder system ABIDRIVE-CW cpl.		525.1001	7010
	Drive rolls for aluminium wire			
w/o. fig.	Drive roll for aluminium 0.6 / 0.8 mm (U-groove)		525.1027.1	7011
w/o. fig.	Drive roll for aluminium 1.0 / 1.0 mm (U-groove)		525.1028.1	7011
w/o. fig.	Drive roll for aluminium 1.0 / 1.2 mm (U-groove)		525.1029.1	7011
w/o. fig.	Drive roll for aluminium 1.2 / 1.2 mm (U-groove)		525.1030.1	7011
	Drive rolls steel / CuSi			
w/o. fig.	Drive roll for steel / CuSi 0.8 / 0.8 mm (V-groove)		525.1031.1	7011
w/o. fig.	Drive roll for steel / CuSi 1.0 / 1.0 mm (V-groove)		525.1032.1	7011
w/o. fig.	Drive roll for steel / CuSi 1.0 / 1.2 mm (V-groove)		525.1033.1	7011
w/o. fig.	Drive roll for steel / CuSi 1.2 / 1.2 mm (V-groove)		525.1034.1	7011
	TIG intermediate cable assembly			
w/o. fig.	TIG intermediate cable assembly BSB 50-70; BLS-01A; BHC-11; for EWM®; 2.00 m		525.1002	2020
w/o. fig.	TIG intermediate cable assembly BSB 50-70; BLS-01B; BHC-16; for Lorch®; 2.00 m		525.1003	2020
w/o. fig.	TIG intermediate cable assembly BSB 50-70; BLS-03A; BHC-16; for Rehmann®; 2.00 m		525.1004	2020
w/o. fig.	TIG intermediate cable assembly BCS-11; BLS-46B; BHC-12; for Kemppi®; 2.00 m		525.1005	2020
w/o. fig.	TIG intermediate cable assembly BCS-11; BLS-46B; BHC-00; for Kemppi®; 2.00 m		525.1006	2020
w/o. fig.	TIG intermediate cable assembly BCS-03; BLS-01A; BHC-12; for Merkle®; 2.00 m		525.1007	2020
w/o. fig.	TIG intermediate cable assembly BCS-06; BLS-15A; BHC-00; for Fronius®; 2.00 m		525.1008	2020
w/o. fig.	TIG intermediate cable assembly BSB 50-70; BLS-01B; BHC-11; for Jäckle®; 2.00 m		525.1009	2020
w/o. fig.	TIG intermediate cable assembly BCS-36; BLS-15A; BHC-12; for Fronius®; 2.00 m		525.1010	2020
w/o. fig.	TIG intermediate cable assembly BCS-06; BLS-10A; BHC-15; for Kemppi®; 2.00 m		525.1011	2020
w/o. fig.	TIG intermediate cable assembly BSB 50-70; BLS-09A; BHC-21; for Esab®; 2.00 m		525.1012	2020
w/o. fig.	TIG intermediate cable assembly BCS-19; BLS-04A; BHC-00; for Oerlikon®; 2.00 m		525.1013	2020
w/o. fig.	TIG intermediate cable assembly BCS-25; BLS-04A; BHC-12; for Oerlikon®; 2.00 m		525.1019	2020
w/o. fig.	TIG intermediate cable assembly BCS-07; BLS-99A; BHC-12; for Esab®; 2.00 m		525.1020	2020

TIG manual welding torches ABITIG® with cold wire feed

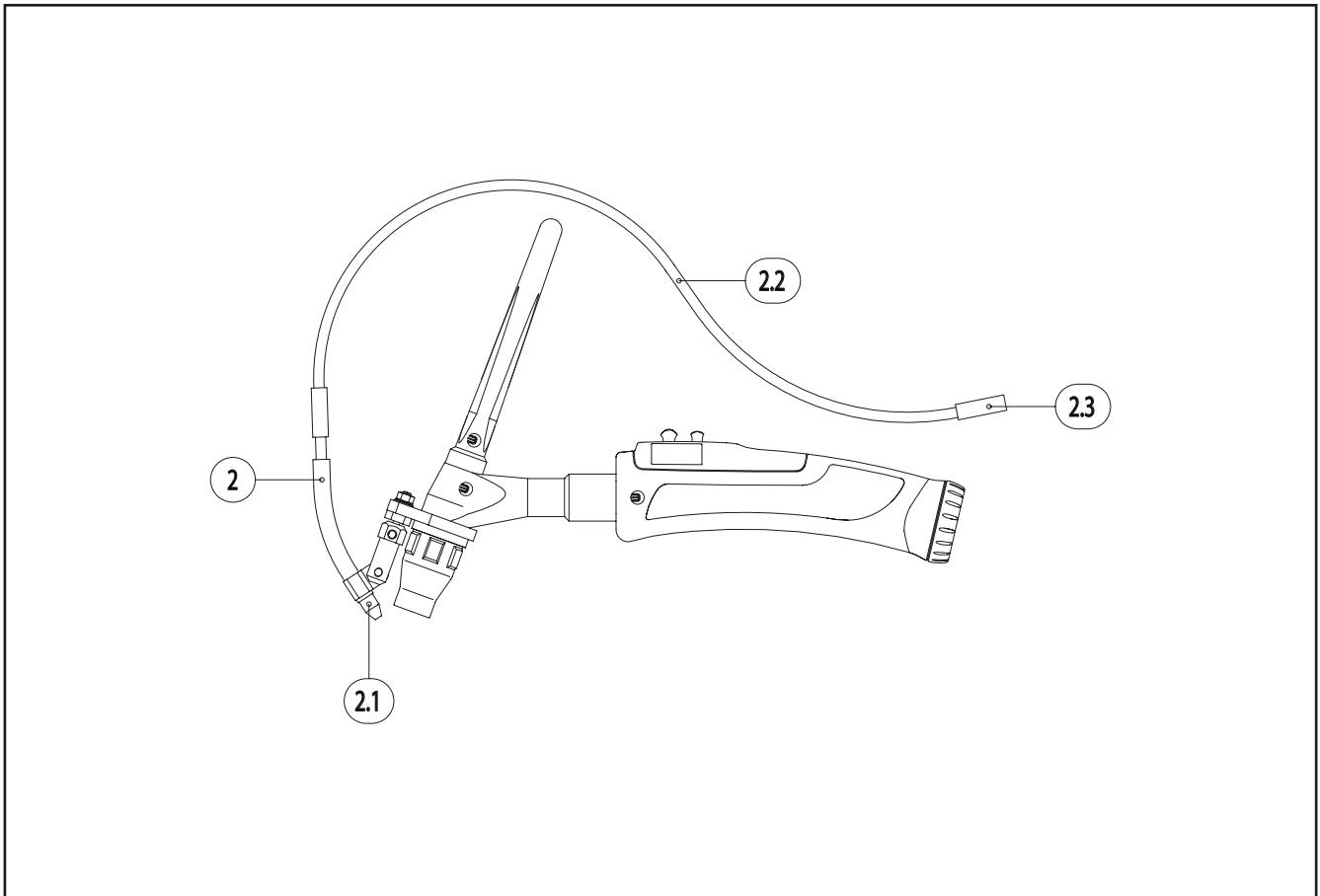

Pos.	Description	Units	Part-No.	Product-group
	TIG manual welding torches ABITIG® with cold wire feed			
w/o. fig.	ABITIG® 260 W with cold wire feed (4.00 m; BIS-25; BHC-12; WZ-2)		777.2005	2502
w/o. fig.	ABITIG® 450 W with cold wire feed (4.00 m; BIS-25; BHC-12; WZ-2)		775.2541	2502
	Cold wire feed			
2	Cold wire feeding cpl. for ABITIG® 260 W		729.0084	2100
	Wear parts			
2.1	Cold wire feeding tip Ø 0.8 mm		729.0071	2101
2.1	Cold wire feeding tip Ø 1.0 mm		729.0072	2101
2.1	Cold wire feeding tip Ø 1.2 mm		729.0073	2101
2.1	Cold wire feeding tip Ø 1.6 mm		729.0074	2101
2.2	Cold wire guide liner 2.0x4.5x45 mm		729.0080	2101
2.3	Double nipple		729.0057	2101
w/o. fig.	Polyamid core liner 2.0/4.0; wire electrode Ø 1.0 - 1.2; for 4.00 m		128.0015	1034
w/o. fig.	PTFE carbon core liner 2.0/4.0; wire electrode Ø 1.0 - 1.2; for 4.00 m		127.0007	1034
w/o. fig.	Nipple for core liner at Ø 4.0	20 Pcs.	131.0001	1095

TIG machine welding torches ABITIG®-MT with cold wire feed

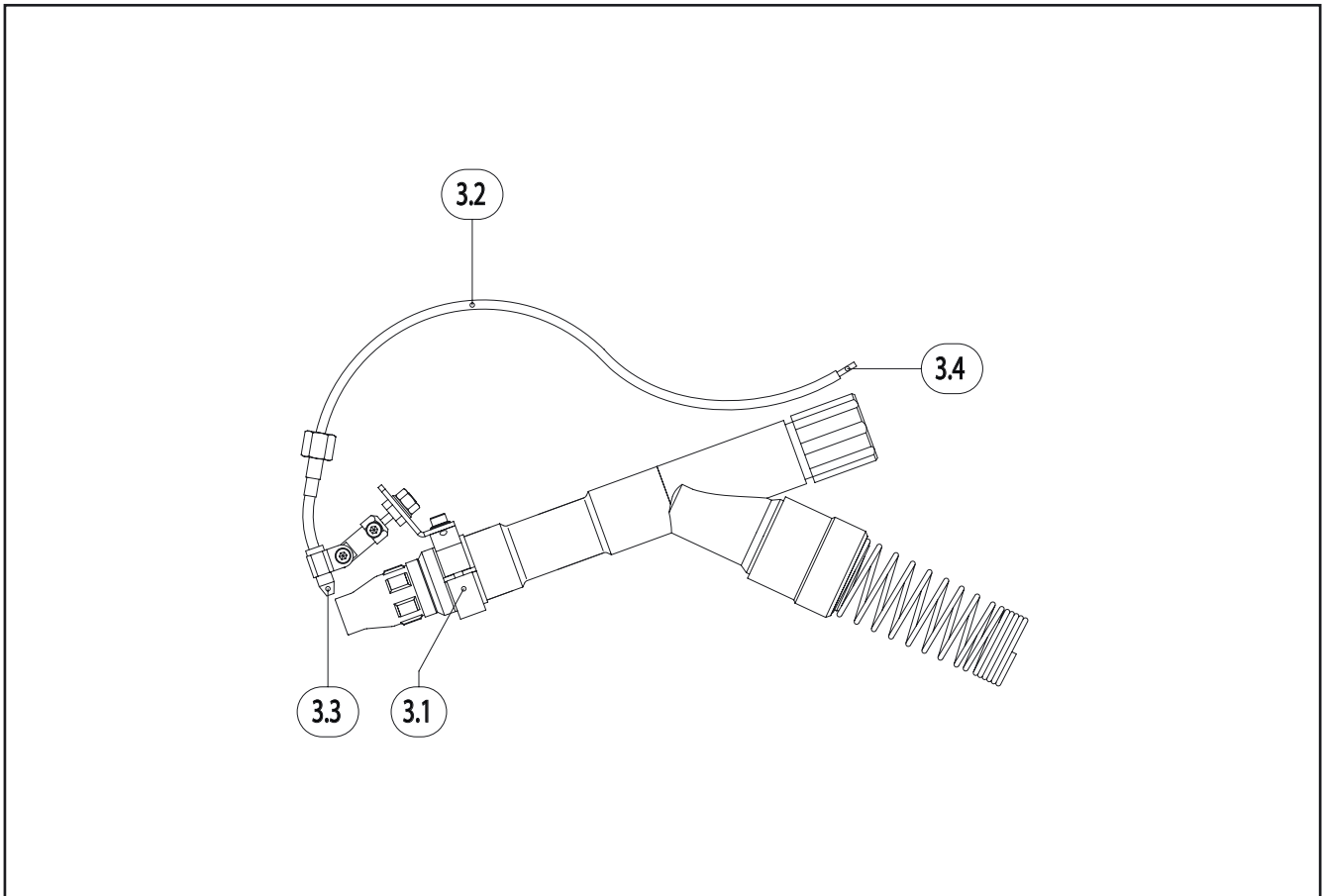

Pos.	Description	Units	Part-No.	Product-group
	TIG machine welding torches ABITIG®-MT with cold wire feed (Direct connection)			
w/o. fig.	ABITIG® 260 W MT with cold wire feed (1.50 m; WZ-2)		525.1016	2512
w/o. fig.	ABITIG® 260 W MT with cold wire feed (3.00 m; WZ-2)		525.1017	2512
w/o. fig.	ABITIG® 260 W MT with cold wire feed (4.00 m; WZ-2)		525.1018	2512
w/o. fig.	ABITIG® 300 W MT with cold wire feed (1.50 m; WZ-2)		525.1021	2512
w/o. fig.	ABITIG® 300 W MT with cold wire feed (3.00 m; WZ-2)		525.1022	2512
w/o. fig.	ABITIG® 300 W MT with cold wire feed (4.00 m; WZ-2)		525.1023	2512
w/o. fig.	ABITIG® 400 W MT with cold wire feed (1.50 m; WZ-2)		525.1024	2512
w/o. fig.	ABITIG® 400 W MT with cold wire feed (3.00 m; WZ-2)		525.1025	2512
w/o. fig.	ABITIG® 400 W MT with cold wire feed (4.00 m; WZ-2)		525.1026	2512
	Cold wire feed			
3.1	Cold wire feed cpl. for ABITIG®-MT 260 W / 300 W / 400 W (length = 4.00 m)		525.1014	2101
	Wear parts			
3.2	Cold wire feeding tip Ø 1.0 mm		729.0061	2101
3.2	Cold wire feeding tip Ø 1.2 mm		729.0059	2101
3.2	Cold wire feeding tip Ø 1.6 mm		729.0062	2101
3.3	Polyamid core liner 2.0/4.0; wire electrode Ø 1.0 - 1.2; for 4.00 m		128.0015	1034
3.3	PTFE carbon core liner 2.0/4.0; wire electrode Ø 1.0 - 1.2; for 4.00 m		127.0007	1034
w/o. fig.	Nipple for core liner at Ø 4.0	20 Pcs.	131.0001	1095

Notes

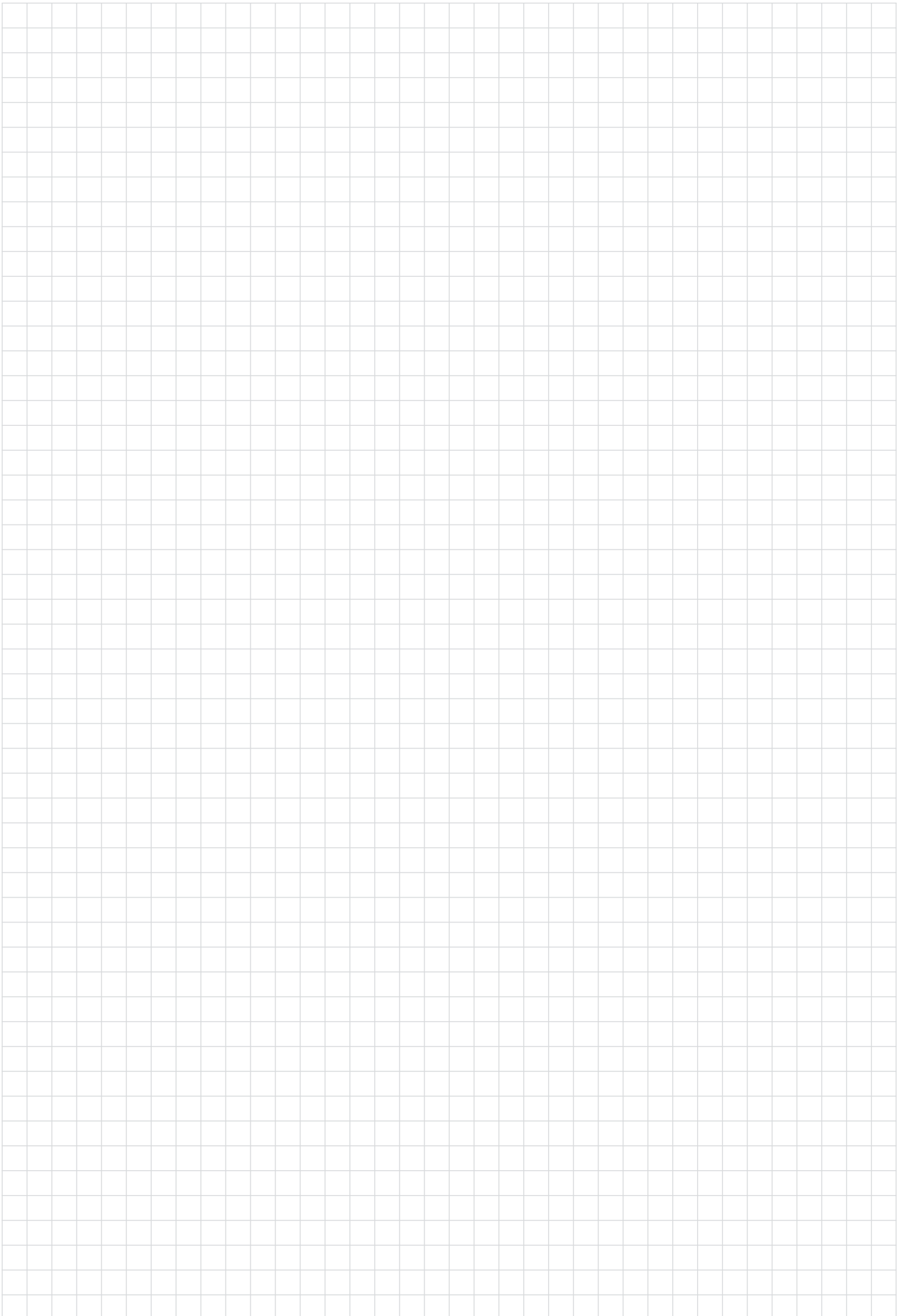

Spare Parts List (numerical)



Spare Parts List (numerical)

Ident-No.	Description	Units	Product-group
000.0552	Pan head screw M4x6	20 Pcs.	9010
009.0201	Rounded countersunk head screw M4x6	20 Pcs.	9010
100.0028	Control cable 7-pole; protected	100 m	4050
100.0100	Control cable 3-pole	100 m	4050
100.0112	Control cable 6-pole	100 m	4050
102.0124	Hose Ø 3x1.5	100 m	4050
104.0007	Shrink hose Ø 19.1 mm	60 m	4050
105.0005	Outer cover rubber Ø 20x1.5	40 m	4050
105.0019	Outer cover rubber Ø 25x1.25	40 m	4050
108.0028	Leather hose High Flex Ø 23x1 (0.8 m)		2005
109.0011	Hose 1 black Ø 3.9x1.5	100 m	4050
109.0019	Hose 9 black Ø 18.2x1.25	60 m	4050
109.0020	Hose 10 black Ø 22x1.25	40 m	4050
109.0023	Hose 13 black Ø 4.2x1.5	100 m	4050
109.0040	Hose 30 black Ø 4.9x1.5	100 m	4050
109.0059	Hose 49 black Ø 3.9x1.5	40 m	4050
118.0019	Power cable type 35 for 4.00 m; with welding cable plug ABI-CM 35-50		2005
118.0021	Power cable type 35 for 8.00 m; with welding cable plug ABI-CM 35-50		2005
118.0042	Power cable type 16 for 4.00 m		2005
118.0043	Power cable type 16 for 8.00 m		2005
127.0007	PTFE carbon core liner 2.0/4.0; wire electrode Ø 1.0 - 1.2; for 4.00 m		1034
128.0015	Polyamid core liner 2.0/4.0; wire electrode Ø 1.0 - 1.2; for 4.00 m		1034
131.0001	Nipple for core liner at Ø 4.0	20 Pcs.	1095
150.0002	Power cable High Flex (ABITIG® 260 W) for 4.00 m		2555
150.0003	Power cable High Flex (ABITIG® 260 W) for 8.00 m		2555
150.0015	Power cable (ABITIG® 20, ABITIG® 24 W) for 4.00 m		2005
150.0016	Power cable (ABITIG® 20, ABITIG® 24 W) for 8.00 m		2005
150.0017	Power cable (ABITIG® 20, ABITIG® 24 W) for 12.00 m		2005
150.0018	Power cable (ABITIG® 18, ABITIG® 18 SC) for 4.00 m		2005
150.0019	Power cable (ABITIG® 18, ABITIG® 18 SC) for 8.00 m		2005
150.0020	Power cable (ABITIG® 18, ABITIG® 18 SC) for 12.00 m		2005
150.0036	Power cable High Flex (ABITIG® 200) for 4.00 m		2555
150.0037	Power cable High Flex (ABITIG® 200) for 8.00 m		2555
150.0040	Power cable High Flex (ABITIG® 150) for 4.00 m		2555
150.0041	Power cable High Flex (ABITIG® 150) for 8.00 m		2555
150.0054	Power cable (ABITIG® 450 W) for 4.00 m		2555
150.0055	Power cable (ABITIG® 450 W) for 8.00 m		2555
150.0056	Power cable High Flex (ABITIG® 9) for 4.00 m		2005
150.0057	Power cable High Flex (ABITIG® 9) for 8.00 m		2005
150.0058	Power cable High Flex (ABITIG® 9) for 12.00 m		2005
150.0059	Power cable High Flex (ABITIG® 26) for 4.00 m		2005
150.0060	Power cable High Flex (ABITIG® 26) for 8.00 m		2005
150.0061	Power cable High Flex (ABITIG® 26) for 12.00 m		2005
150.0062	Power cable High Flex (ABITIG® 20, ABITIG® 24 W) for 4.00 m		2005
150.0063	Power cable High Flex (ABITIG® 20, ABITIG® 24 W) for 8.00 m		2005
150.0064	Power cable High Flex (ABITIG® 20, ABITIG® 24 W) for 12.00 m		2005
150.0065	Power cable High Flex (ABITIG® 17, ABITIG® 24 G) for 4.00 m		2005
150.0066	Power cable High Flex (ABITIG® 17, ABITIG® 24 G) for 8.00 m		2005
150.0067	Power cable High Flex (ABITIG® 17, ABITIG® 24 G) for 12.00 m		2005
150.0068	Power cable High Flex (ABITIG® 18, ABITIG® 18 SC) for 4.00 m		2005
150.0069	Power cable High Flex (ABITIG® 18, ABITIG® 18 SC) for 8.00 m		2005
150.0070	Power cable High Flex (ABITIG® 18, ABITIG® 18 SC) for 12.00 m		2005
150.0071	Power cable High Flex (ABITIG® 12-1) for 4.00 m		2005
150.0072	Power cable High Flex (ABITIG® 12-1) for 8.00 m		2005
150.0073	Power cable High Flex (ABITIG® 12-1) for 12.00 m		2005
150.0074	Power cable (ABITIG® 12-1) for 4.00 m		2005

Spare Parts List (numerical)

Ident-No.	Description	Units	Product-group
150.0075	Power cable (ABITIG® 12-1) for 8.00 m		2005
150.0076	Power cable (ABITIG® 12-1) for 12.00 m		2005
150.0082	Power cable High Flex (ABITIG® 260 W) for 12.00 m		2555
150.0083	Power cable (ABITIG® 450 W) for 12.00 m		2555
150.0084	Power cable (ABITIG® 9, ABITIG® 17, ABITIG® 24 G) for 4.00 m		2005
150.0085	Power cable (ABITIG® 9, ABITIG® 17, ABITIG® 24 G) for 8.00 m		2005
150.0086	Power cable (ABITIG® 9, ABITIG® 17, ABITIG® 24 G) for 12.00 m		2005
150.0087	Power cable (ABITIG® 26) for 4.00 m		2005
150.0088	Power cable (ABITIG® 26) for 8.00 m		2005
150.0089	Power cable (ABITIG® 26) for 12.00 m		2005
150.0099	Power cable (ABITIG® 260 W) for 4.00 m		2555
150.0100	Power cable (ABITIG® 260 W) for 8.00 m		2555
150.0101	Power cable (ABITIG® 260 W) for 12.00 m		2555
150.0111	Power cable (ABITIG® 150) for 4.00 m		2555
150.0112	Power cable (ABITIG® 150) for 8.00 m		2555
150.0113	Power cable (ABITIG® 150) for 12.00 m		2555
150.0114	Power cable High Flex (ABITIG® 200) for 12.00 m		2555
150.0164	Power cable High Flex (ABITIG® 260 W) for 4.00 m		2555
150.0165	Power cable High Flex (ABITIG® 260 W) for 8.00 m		2555
150.0166	Power cable High Flex (ABITIG® 260 W) for 12.00 m		2555
150.0167	Power cable High Flex (ABITIG® 450 W) for 4.00 m		2555
150.0168	Power cable High Flex (ABITIG® 450 W) for 8.00 m		2555
150.0169	Power cable High Flex (ABITIG® 450 W) for 12.00 m		2555
150.0170	Power cable (ABITIG® 200) for 4.00 m		2555
150.0171	Power cable (ABITIG® 200) for 8.00 m		2555
150.0172	Power cable (ABITIG® 200) for 12.00 m		2555
150.0175	Power cable High Flex (ABITIG® MT) for 4.00 m		2555
150.0190	Power cable High Flex (ABITIG® 150) for 12.00 m		2555
150.0194	Power cable High Flex (ABITIG® 450 W SC) for 8.00 m		2555
150.0203	Power cable High Flex (ABITIG® 450 W SC) for 4.00 m		2555
150.0204	Power cable High Flex (ABITIG® 450 W SC) for 12.00 m		2555
150.0255.1	Power cable High Flex (ABITIG® 20) for 4.00 m		2005
150.0256.1	Power cable High Flex (ABITIG® 20) for 8.00 m		2005
150.0257.1	Power cable High Flex (ABITIG® 20) for 12.00 m		2005
150.0259.1	Power cable (ABITIG® 20) for 4.00 m		2005
150.0260.1	Power cable (ABITIG® 20) for 8.00 m		2005
150.0261.1	Power cable (ABITIG® 20) for 12.00 m		2005
165.0028	O-Ring 4.6x2	20 Pcs.	9010
165.0030	O-Ring 9x2	20 Pcs.	9010
165.0079	O-Ring 13.46x2.08	20 Pcs.	9010
165.0097	O-Ring 10x1.5	20 Pcs.	9010
173.0001	Hose clamp Ø 9.0 mm with ring (mark 9.5)	20 Pcs.	9010
173.0005	Hose clamp Ø 8.2 mm with ring (mark 8.7)	20 Pcs.	9010
173.0006	Hose clamp Ø 6.2 mm with ring (mark 6.6)	20 Pcs.	9010
173.0007	Hose clamp Ø 7.5 mm with ring (mark 8.0)	20 Pcs.	9010
173.0008	Hose clamp Ø 5.7 mm with ring (mark 6.1)	20 Pcs.	9010
173.0009	Hose clamp Ø 6.5 mm with ring (mark 7.0)	20 Pcs.	9010
175.0005	Amphenol plug 6-pole		9010
175.0006	Amphenol plug 4-pole		9010
175.0009	Tuchel plug 3-pole		9010
175.0011	Tuchel plug 5-pole		9010
175.0012	Tuchel plug 5-pole (screwed)		9010
175.0046	Tuchel rectangle plug connector 9-pole		9010
175.0063	Cable plug 5-pole		9010
175.0064	Amphenol plug 10-pole		9010
175.0067	Amphenol plug 2-pole		9010

Spare Parts List (numerical)

Ident-No.	Description	Units	Product-group
175.0102	Cable plug 5-pole		9010
175.0127	Amphenol plug 2-pole		9010
175.0129	Amphenol plug 14-pole		9010
175.0155	Binder plug 7-pole		9010
175.0247	Amphenol plug 8-pole		9010
175.0249	Plug 7-pole		9010
175.0273	Tuchel plug 7-pole		9010
175.0290	Dioden plug 3-pole		9010
175.0301	Harting plug 6-pole		9010
175.0341	Round plug connector 3-pole		9010
175.0343	DDK plug 5-pole		9010
175.0344	DDK plug 10-pole		9010
175.0382	Amphenol plug 7-pole (Z-version)		9010
175.0400	Redel plug 2-pole		9010
175.0404	AMP plug 14-pole cpl.		9010
175.0405	Amphenol plug 18-pole cpl.		9010
175.0406	Burndy plug 8-pole cpl.		9010
175.0407	Burndy plug 12-pole cpl.		9010
175.0434	Klinken plug 3-pole		9010
175.0449	Neutrik plug 3-pole		9010
175.0484	Cable plug 7-pole		9010
175.0525.1	AMP plug 8-pole cpl.		9010
177.0007	Quick coupling ND 5		1092
180.0130.1	Handle ABITIG® GRIP without module		2005
180.0131.1	Handgriff ABITIG® GRIP Little without module		2005
184.0162	HF-control cable filter DGF 3		9010
400.0046	Coupling nut M10x1	10 Pcs.	9010
400.0137	Coupling nut M38x2		9010
400.0351	Strain relief		2005
400.0377	Hose coupling BS		2005
400.0378	Hose coupling MS		2005
400.0379	Strain relief		2005
400.0380	Hose coupling BS		2005
400.0381	Hose coupling MS		2005
400.0391	Hose coupling cpl.		2005
400.0392	Hose coupling cpl.		2005
400.0412	Strain relief ERGO		9010
400.0413	Strain relief		9010
400.0987	Lock ring ND 31		9010
400.1258	Socket joint ABITIG® GRIP		2005
400.1275.1	Control module BIS-51 single push-button		2005
400.1276.1	Control module BIS-52 double push-button / button long		2005
400.1277.1	Control module BIS-95 UP / DOWN (compatible with Lorch)		2005
400.1278.1	Control module BIS-54 double push-button with potentiometer 10 k-Ohm		2005
400.1279.1	Control module BIS-65 UP / DOWN (device-dependent)		2005
400.1280.1	Control module BIS-60 double push-button for high switching current (up to 2 A)		2005
400.1281.1	Control module BIS-59 single push-button with potentiometer 10 k-Ohm		2005
400.1282.1	Control module BIS-67 double push-button / compensator		2005
400.1292.1	Control module BIS-52 double push-button		2005
400.1296.1	Control module BIS-51 single push-button		2005
400.1318.1	Control module BIS-65 UP / DOWN (device-dependent)		2005
400.1327.1	Control module BIS-64 double push-button with potentiometer 1 k-Ohm		2005
400.1328.1	Control module BIS-74 double push-button with potentiometer 2.2 k-Ohm		2005
400.1329.1	Control module BIS-84 double push-button with potentiometer 4.7 k-Ohm		2005
400.1330.1	Control module BIS-94 double push-button with potentiometer 47 k-Ohm		2005
500.0081	Coupling nut G 3/8"	10 Pcs.	9010

Spare Parts List (numerical)

Ident-No.	Description	Units	Product-group
500.0082	Coupling nut G 1/4"	10 Pcs.	9010
500.0087	Hose connector G 1/4"	10 Pcs.	9010
500.0106	Coupling nut 9/16"-18G UNF	10 Pcs.	9010
500.0110	Coupling nut M12x1	10 Pcs.	9010
500.0112	Hose connector for M12x1	10 Pcs.	9010
500.0121	Inverted nut 5/8"-18G	10 Pcs.	9010
500.0122	Inverted nut 5/8"-18G l.h.	10 Pcs.	9010
500.0136	Hose connector G 1/8" / M10x1	10 Pcs.	9010
500.0160	Cable support		9010
500.0162	Coupling nut 5/8"-18G	10 Pcs.	9010
500.0203	Hose connector for 9/16"-18G UNF	10 Pcs.	9010
500.0213	Adaptor nut M33x2		9010
500.0226	Cable support spring		9010
500.0227	Cable support spring		9010
500.0247	Hose connector for G 1/4"	10 Pcs.	9010
500.0248	Hose connector for G 3/8"	10 Pcs.	9010
500.0251	Screw cap 1	20 Pcs.	9010
500.0252	Strain relief		9010
500.0271	Rubber sleeve		9010
500.0272	Rubber sleeve		9010
500.0317	Hose connector for 5/8"-18G	10 Pcs.	9010
500.0362	Screw cap 2	20 Pcs.	9010
500.0364	Coupling nut G1/4" (Esseti)	10 Pcs.	9010
500.0415	Cable support machine side large		9010
500.0416	Cable support machine side cover large		9010
500.0427	Cable support machine side small		9010
500.0428	Cable support machine side cover small		9010
500.0431	Sealing cover		9010
500.0432	Cable support machine side small		9010
500.0433	Cable support machine side cover small		9010
501.0126	Plug nipple ND 2.7	10 Pcs.	9010
501.0127	Adaptor nut		9010
501.2165	Plug nipple NW 5	20 Pcs.	9010
501.2166	Code colour ring red	20 Pcs.	9010
501.2167	Code colour ring blue	20 Pcs.	9010
501.2223	Plug nipple ND 2.7 (migatronic)	10 Pcs.	9010
501.2230	Plug nipple ND 7.2	10 Pcs.	9010
501.2251	Plug nipple NW 5 (Dalex)		9010
511.0305	Welding cable plug ABI-CM 10-25		4002
511.0315	Welding cable plug ABI-CM 35-50		4002
511.0398	Rubber sleeve		4001
525.1001	Cold wire feeder system ABIDRIVE-CW cpl.		7010
525.1002	TIG intermediate cable assembly BSB 50-70; BLS-01A; BHC-11; for EWM®; 2.00 m		2020
525.1003	TIG intermediate cable assembly BSB 50-70; BLS-01B; BHC-16; for Lorch®; 2.00 m		2020
525.1004	TIG intermediate cable assembly BSB 50-70; BLS-03A; BHC-16; for Rehm®; 2.00 m		2020
525.1005	TIG intermediate cable assembly BCS-11; BLS-46B; BHC-12; for Kemppi®; 2.00 m		2020
525.1006	TIG intermediate cable assembly BCS-11; BLS-46B; BHC-00; for Kemppi®; 2.00 m		2020
525.1007	TIG intermediate cable assembly BCS-03; BLS-01A; BHC-12; for Merkle®; 2.00 m		2020
525.1008	TIG intermediate cable assembly BCS-06; BLS-15A; BHC-00; for Fronius®; 2.00 m		2020
525.1009	TIG intermediate cable assembly BSB 50-70; BLS-01B; BHC-11; for Jäckle®; 2.00 m		2020
525.1010	TIG intermediate cable assembly BCS-36; BLS-15A; BHC-12; for Fronius®; 2.00 m		2020
525.1011	TIG intermediate cable assembly BCS-06; BLS-10A; BHC-15; for Kemppi®; 2.00 m		2020
525.1012	TIG intermediate cable assembly BSB 50-70; BLS-09A; BHC-21; for Esab®; 2.00 m		2020
525.1013	TIG intermediate cable assembly BCS-19; BLS-04A; BHC-00; for Oerlikon®; 2.00 m		2020
525.1014	Cold wire feed cpl. for ABITIG®-MT 260 W / 300 W / 400 W (length = 4.00 m)		2101
525.1016	ABITIG® 260 W MT with cold wire feed (1.50 m; WZ-2)		2512

Spare Parts List (numerical)

Ident-No.	Description	Units	Product-group
525.1017	ABITIG® 260 W MT with cold wire feed (3.00 m; WZ-2)		2512
525.1018	ABITIG® 260 W MT with cold wire feed (4.00 m; WZ-2)		2512
525.1019	TIG intermediate cable assembly BCS-25; BLS-04A; BHC-12; for Oerlikon®; 2.00 m		2020
525.1020	TIG intermediate cable assembly BCS-07; BLS-99A; BHC-12; for Esab®; 2.00 m		2020
525.1021	ABITIG® 300 W MT with cold wire feed (1.50 m; WZ-2)		2512
525.1022	ABITIG® 300 W MT with cold wire feed (3.00 m; WZ-2)		2512
525.1023	ABITIG® 300 W MT with cold wire feed (4.00 m; WZ-2)		2512
525.1024	ABITIG® 400 W MT with cold wire feed (1.50 m; WZ-2)		2512
525.1025	ABITIG® 400 W MT with cold wire feed (3.00 m; WZ-2)		2512
525.1026	ABITIG® 400 W MT with cold wire feed (4.00 m; WZ-2)		2512
525.1027.1	Drive roll for aluminium 0.6 / 0.8 mm (U-groove)		7011
525.1028.1	Drive roll for aluminium 1.0 / 1.0 mm (U-groove)		7011
525.1029.1	Drive roll for aluminium 1.0 / 1.2 mm (U-groove)		7011
525.1030.1	Drive roll for aluminium 1.2 / 1.2 mm (U-groove)		7011
525.1031.1	Drive roll for steel / CuSi 0.8 / 0.8 mm (V-groove)		7011
525.1032.1	Drive roll for steel / CuSi 1.0 / 1.0 mm (V-groove)		7011
525.1033.1	Drive roll for steel / CuSi 1.0 / 1.2 mm (V-groove)		7011
525.1034.1	Drive roll for steel / CuSi 1.2 / 1.2 mm (V-groove)		7011
701.0107	Ceramic gas nozzle; no. 4; Ø 6.5 mm; 47.0 mm long; (10N50)	10 Pcs.	2004
701.0108	Ceramic gas nozzle; no. 5; Ø 8.0 mm; 47.0 mm long; (10N49)	10 Pcs.	2004
701.0109	Ceramic gas nozzle; no. 6; Ø 9.5 mm; 47.0 mm long; (10N48)	10 Pcs.	2004
701.0110	Ceramic gas nozzle; no. 7; Ø 11.0 mm; 47.0 mm long; (10N47)	10 Pcs.	2004
701.0111	Ceramic gas nozzle; no. 8; Ø 12.5 mm; 47.0 mm long; (10N46)	10 Pcs.	2004
701.0113	Ceramic gas nozzle; no. 10; Ø 16.0 mm; 47.0 mm long; (10N45)	10 Pcs.	2004
701.0114	Ceramic gas nozzle; no. 12; Ø 19.5 mm; 50.0 mm long; (10N44)	10 Pcs.	2004
701.0115	Ceramic gas nozzle; no. 5; Ø 8.0 mm; 76.0 mm long; (10N49L)	10 Pcs.	2004
701.0116	Ceramic gas nozzle; no. 6; Ø 9.5 mm; 76.0 mm long; (10N48L)	10 Pcs.	2004
701.0117	Ceramic gas nozzle; no. 7; Ø 11.0 mm; 76.0 mm long; (10N47L)	10 Pcs.	2004
701.0118	Ceramic gas nozzle; no. 7; Ø 11.0 mm; 48.0 mm long with metal shield; (10N53)		2004
701.0120	Ceramic gas nozzle; no. 8; Ø 12.5 mm; 48.0 mm long with metal shield; (10N52)		2004
701.0122	Ceramic gas nozzle; no. 10; Ø 16.0 mm; 48.0 mm long with metal shield; (10N51)		2004
701.0124	Ceramic gas nozzle; no. 5; Ø 8.0 mm; 48.0 mm long with metal shield; (10N55)		2004
701.0126	Ceramic gas nozzle; no. 6; Ø 9.5 mm; 48.0 mm long with metal shield; (10N54)		2004
701.0129	Ceramic spot weld nozzle; no 8; Ø 12.5 mm; 55.0 mm long with metal shield (10N52P)		2004
701.0130	Adaptor (54N01)	10 Pcs.	2003
701.0169	Collet for electrode Ø 0.5 mm; 52.0 mm long; (10N21D)	10 Pcs.	2007
701.0170	Collet for electrode Ø 1.2 mm; 52.0 mm long	10 Pcs.	2007
701.0171	Collet for electrode Ø 1.0 mm; 52.0 mm long; (10N22D)	10 Pcs.	2007
701.0172	Collet for electrode Ø 1.6 mm; 52.0 mm long; (10N23D)	10 Pcs.	2007
701.0173	Collet for electrode Ø 2.4 mm; 52.0 mm long; (10N24D)	10 Pcs.	2007
701.0174	Collet for electrode Ø 3.2 mm; 52.0 mm long; (10N25D)	10 Pcs.	2007
701.0175	Collet for electrode Ø 4.0 mm; 52.0 mm long; (54N20D)	10 Pcs.	2007
701.0176	Collet for electrode Ø 2.0 mm; 52.0 mm long	10 Pcs.	2007
701.0190	Collet body for electrode Ø 0.5 - 1.2 mm; (10N30)	10 Pcs.	2008
701.0191	Collet body for electrode Ø 1.6 mm; (10N31)	10 Pcs.	2008
701.0196	Collet body for electrode Ø 2.0 - 2.4 mm; (10N32)	10 Pcs.	2008
701.0197	Collet body for electrode Ø 3.2 mm; (10N28)	10 Pcs.	2008
701.0198	Collet body for electrode Ø 4.0 mm; (406488)	10 Pcs.	2008
701.0199	Insulator	10 Pcs.	2003
701.0201	Collet body for electrode with gas lens Ø 0.5 - 1.0 mm; (45V24)	10 Pcs.	2016
701.0203	Collet body for electrode with gas lens Ø 1.6 mm; (45V25)	10 Pcs.	2016
701.0207	Collet body for electrode with gas lens Ø 2.0 - 2.4 mm; (45V26)	10 Pcs.	2016
701.0209	Collet body for electrode with gas lens Ø 3.2 mm; (45V27)	10 Pcs.	2016
701.0211	Collet body for electrode with gas lens Ø 4.0 mm; (45V28)	10 Pcs.	2016
701.0240	Back cap, short; (41V33)	10 Pcs.	2009
701.0244	Back cap, medium; (41V35)	10 Pcs.	2009

Spare Parts List (numerical)

Ident-No.	Description	Units	Product-group
701.0247	Back cap, long; (41V24)	10 Pcs.	2009
701.0249	Collet for electrode Ø 0.5 mm; 25.4 mm long; (13N20)	10 Pcs.	2007
701.0250	Collet for electrode Ø 1.0 mm; 25.4 mm long; (13N21)	10 Pcs.	2007
701.0251	Collet for electrode Ø 1.6 mm; 25.4 mm long; (13N22)	10 Pcs.	2007
701.0252	Collet for electrode Ø 2.4 mm; 25.4 mm long; (13N23)	10 Pcs.	2007
701.0253	Collet for electrode Ø 3.2 mm; 25.4 mm long; (13N24)	10 Pcs.	2007
701.0254	Collet for electrode Ø 1.2 mm; 25.4 mm long	10 Pcs.	2007
701.0255	Collet for electrode Ø 2.0 mm; 25.4 mm long	10 Pcs.	2007
701.0275	Collet body for electrode Ø 0.5 - 1.0 mm; (13N26)	10 Pcs.	2008
701.0276	Collet body for electrode Ø 1.6 mm; (13N27)	10 Pcs.	2008
701.0277	Collet body for electrode Ø 2.4 mm; (13N28)	10 Pcs.	2008
701.0278	Collet body for electrode Ø 3.2 mm; (13N29)	10 Pcs.	2008
701.0279	Collet body for electrode Ø 1.2 mm	10 Pcs.	2008
701.0280	Collet body for electrode Ø 2.0 mm	10 Pcs.	2008
701.0281	Ceramic gas nozzle; no. 4; Ø 6.5 mm; 30.0 mm long; (13N08)	10 Pcs.	2004
701.0282	Ceramic gas nozzle; no. 5; Ø 8.0 mm; 30.0 mm long; (13N09)	10 Pcs.	2004
701.0283	Ceramic gas nozzle; no. 6; Ø 9.5 mm; 30.0 mm long; (13N10)	10 Pcs.	2004
701.0284	Ceramic gas nozzle; no. 7; Ø 11.0 mm; 30.0 mm long; (13N11)	10 Pcs.	2004
701.0285	Ceramic gas nozzle; no. 8; Ø 12.5 mm; 30.0 mm long; (13N12)	10 Pcs.	2004
701.0286	Ceramic gas nozzle; no. 10; Ø 16.0 mm; 30.0 mm long; (13N13)	10 Pcs.	2004
701.0289	Ceramic gas nozzle; no. 4; Ø 6.5 mm; 48.0 mm long; (796F71)	10 Pcs.	2004
701.0290	Ceramic gas nozzle; no. 5; Ø 8.0 mm; 48.0 mm long; (796F72)	10 Pcs.	2004
701.0291	Ceramic gas nozzle; no. 6; Ø 9.5 mm; 48.0 mm long; (796F73)	10 Pcs.	2004
701.0293	Ceramic gas nozzle; no. 4; Ø 6.5 mm; 63.0 mm long; (796F75)	10 Pcs.	2004
701.0294	Ceramic gas nozzle; no. 5; Ø 8.0 mm; 63.0 mm long; (796F76)	10 Pcs.	2004
701.0296	Ceramic gas nozzle; no. 4; Ø 6.5 mm; 89.0 mm long; (796F79)	10 Pcs.	2004
701.0301	Collet body for electrode with gas lens Ø 0.5 - 1.0 mm; (45V41 / 45V42)	10 Pcs.	2016
701.0307	Collet body for electrode with gas lens Ø 1.6 mm; (45V43)	10 Pcs.	2016
701.0309	Collet body for electrode with gas lens Ø 2.4 mm; (45V44)	10 Pcs.	2016
701.0311	Collet body for electrode with gas lens Ø 3.2 mm; (45V45)	10 Pcs.	2016
701.0313	Collet body for electrode with gas lens Ø 1.2 mm	10 Pcs.	2016
701.0315	Collet body for electrode with gas lens Ø 2.0 mm	10 Pcs.	2016
701.0317	Ceramic gas nozzle; no. 4; Ø 6.5 mm; 25.5 mm long; (53N58)	10 Pcs.	2004
701.0318	Ceramic gas nozzle; no. 5; Ø 8.0 mm; 25.5 mm long; (53N59)	10 Pcs.	2004
701.0319	Ceramic gas nozzle; no. 6; Ø 9.5 mm; 25.5 mm long; (53N60)	10 Pcs.	2004
701.0320	Ceramic gas nozzle; no. 7; Ø 11.0 mm; 25.5 mm long; (53N61)	10 Pcs.	2004
701.0420	Ceramic gas nozzle; no. 4; Ø 6.5 mm; 42.0 mm long; (54N18)	10 Pcs.	2004
701.0421	Ceramic gas nozzle; no. 5; Ø 8.0 mm; 42.0 mm long; (54N17)	10 Pcs.	2004
701.0422	Ceramic gas nozzle; no. 6; Ø 9.5 mm; 42.0 mm long; (54N16)	10 Pcs.	2004
701.0423	Ceramic gas nozzle; no. 7; Ø 11.0 mm; 42.0 mm long; (54N15)	10 Pcs.	2004
701.0424	Ceramic gas nozzle; no. 8; Ø 12.5 mm; 42.0 mm long; (54N14)	10 Pcs.	2004
701.0426	Ceramic gas nozzle; no. 12; Ø 19.5 mm; 42.0 mm long; (54N19)	10 Pcs.	2004
701.0427	Ceramic gas nozzle; no. 5; Ø 8.0 mm; 76.0 mm long; (54N17L)	10 Pcs.	2004
701.0428	Ceramic gas nozzle; no. 6; Ø 9.5 mm; 76.0 mm long; (54N16L)	10 Pcs.	2004
701.0429	Ceramic gas nozzle; no. 7; Ø 11.0 mm; 76.0 mm long; (54N15L)	10 Pcs.	2004
701.0452	Collet for electrode Ø 0.5 mm; 14.0 mm long; (53N15)	10 Pcs.	2007
701.0453	Collet for electrode Ø 1.0 mm; 14.0 mm long; (53N16)	10 Pcs.	2007
701.0454	Collet for electrode Ø 1.6 mm; 14.0 mm long; (53N14)	10 Pcs.	2007
701.0455	Collet for electrode Ø 1.2 mm; 14.0 mm long	10 Pcs.	2007
701.0456	Collet for electrode Ø 2.0 mm; 14.0 mm long	10 Pcs.	2007
701.0457	Collet for electrode Ø 2.4 mm; 14.0 mm long; (24C332)	10 Pcs.	2007
701.0458	Insulator (53N22)	10 Pcs.	2003
701.0459	Insulator (53N66)	10 Pcs.	2003
701.0461	Collet for electrode Ø 0.5 mm; 23.0 mm long	10 Pcs.	2007
701.0462	Collet for electrode Ø 1.0 mm; 23.0 mm long; (53N63)	10 Pcs.	2007
701.0463	Collet for electrode Ø 1.6 mm; 23.0 mm long; (54N64)	10 Pcs.	2007

Spare Parts List (numerical)

Ident-No.	Description	Units	Product-group
701.0464	Collet for electrode Ø 1.2 mm; 23.0 mm long	10 Pcs.	2007
701.0465	Collet for electrode Ø 2.4 mm; 23.0 mm long; (24GLC332)	10 Pcs.	2007
701.0466	Collet for electrode Ø 2.0 mm; 23.0 mm long	10 Pcs.	2007
701.0468	Ceramic gas nozzle; no. 4; Ø 6.5 mm; 16.5 mm long; (53N24)	10 Pcs.	2004
701.0469	Ceramic gas nozzle; no. 5; Ø 8.0 mm; 16.5 mm long; (53N25)	10 Pcs.	2004
701.0470	Ceramic gas nozzle; no. 6; Ø 9.5 mm; 16.5 mm long; (53N27)	10 Pcs.	2004
701.0471	Ceramic gas nozzle; no. 4; Ø 6.5 mm; 29.0 mm long; (53N28)	10 Pcs.	2004
701.0472	Ceramic gas nozzle; no. 6; Ø 9.5 mm; 29.0 mm long; (53N26)	10 Pcs.	2004
701.0473	Ceramic gas nozzle; no. 4L; Ø 6.5 mm; 62.5 mm long; (53N24L)	10 Pcs.	2004
701.0474	Ceramic gas nozzle; no. 5L; Ø 8.0 mm; 91.5 mm long; (53N27L)	10 Pcs.	2004
701.0479	Collet body for electrode Ø 0.5 mm; (53N17)	10 Pcs.	2008
701.0480	Collet body for electrode Ø 1.0 mm; (53N18)	10 Pcs.	2008
701.0481	Collet body for electrode Ø 1.6 mm; (53N19)	10 Pcs.	2008
701.0482	Collet body for electrode Ø 2.4 mm; (24CB332)	10 Pcs.	2008
701.0483	Collet body for electrode Ø 1.2 mm	10 Pcs.	2008
701.0484	Collet body for electrode Ø 2.0 mm	10 Pcs.	2008
701.1019	Collet for electrode Ø 1.6 mm; 25.4 mm long; (brass)	10 Pcs.	2007
701.1020	Collet for electrode Ø 2.4 mm; 25.4 mm long; (brass)	10 Pcs.	2007
701.1027	Collet for electrode Ø 1.2 mm; 25.4 mm long; (brass)	10 Pcs.	2007
701.1060	Collet for electrode Ø 0.5 mm; 25.4 mm long; (brass)	10 Pcs.	2007
701.1061	Collet for electrode Ø 1.0 mm; 25.4 mm long; (brass)	10 Pcs.	2007
701.1063	Collet for electrode Ø 3.2 mm; 25.4 mm long; (brass)	10 Pcs.	2007
701.1116	Collet body for electrode with gas lens Ø 1.6 mm; (45V116)	5 Pcs.	2016
701.1117	Collet body for electrode with gas lens Ø 2.4 mm; (45V64)	5 Pcs.	2016
701.1118	Collet body for electrode with gas lens Ø 3.2 mm; (995795)	5 Pcs.	2016
701.1121	Ceramic gas nozzle; no. 12; Ø 19.5 mm; 48,0 mm long; (53N87)	10 Pcs.	2004
701.1122	Adaptor (54N63)	5 Pcs.	2003
701.1199	Ceramic gas nozzle; no. 6; Ø 9.5 mm; 48,0 mm long; (57N75)	10 Pcs.	2004
701.1200	Ceramic gas nozzle; no. 8; Ø 12.5 mm; 48,0 mm long; (57N74)	10 Pcs.	2004
701.1201	Ceramic gas nozzle; no. 10; Ø 16.0 mm; 48,0 mm long (53N88)	10 Pcs.	2004
701.1202	Ceramic gas nozzle; Ø 24.0 mm; 34,0 mm long; (53N89)	10 Pcs.	2004
701.1208	Collet body for electrode with gas lens Ø 4.0 mm; (45V63)	5 Pcs.	2016
701.1218	Collet body for electrode Ø 1.0 - 3.2 mm	10 Pcs.	2008
701.1219	Insulator (18CG20)	10 Pcs.	2003
701.1220	Collet for electrode Ø 1.0 mm; 29.5 mm long; (10N22S)	10 Pcs.	2007
701.1221	Collet for electrode Ø 1.6 mm; 29.5 mm long; (10N23S)	10 Pcs.	2007
701.1222	Collet for electrode Ø 2.0 mm; 29.5 mm long	10 Pcs.	2007
701.1223	Collet for electrode Ø 2.4 mm; 29.5 mm long; (10N24S)	10 Pcs.	2007
701.1224	Collet for electrode Ø 3.2 mm; 29.5 mm long; (10N25S)	10 Pcs.	2007
701.1225	Collet for electrode Ø 0.5 mm; 40.0 mm long; (13N20L)	10 Pcs.	2007
701.1226	Collet for electrode Ø 1.0 mm; 40.0 mm long; (13N21L)	10 Pcs.	2007
701.1227	Collet for electrode Ø 1.6 mm; 40.0 mm long; (13N22L)	10 Pcs.	2007
701.1228	Collet for electrode Ø 2.4 mm; 40.0 mm long; (13N23L)	10 Pcs.	2007
701.1229	Collet for electrode Ø 3.2 mm; 40.0 mm long; (13N24L)	10 Pcs.	2007
701.1230	Collet body for electrode with gas lens Ø 0.5 - 1.0 mm; (45V0204S)	5 Pcs.	2016
701.1231	Collet body for electrode with gas lens Ø 1.6 mm; (45V116S)	5 Pcs.	2016
701.1232	Collet body for electrode with gas lens Ø 2.4 mm; (45V64S)	5 Pcs.	2016
701.1233	Collet body for electrode with gas lens Ø 3.2 mm; (995795S)	5 Pcs.	2016
701.1234	Adaptor (54N63-20)	5 Pcs.	2003
701.1286	Insulator	10 Pcs.	2003
701.1287	Collet body for electrode with gas lens Ø 1.0 mm	10 Pcs.	2016
701.1288	Collet body for electrode with gas lens Ø 1.6 mm	10 Pcs.	2016
701.1289	Collet body for electrode with gas lens Ø 2.4 mm	10 Pcs.	2016
701.1290	Collet body for electrode with gas lens Ø 3.2 mm	10 Pcs.	2016
702.0005	Collet for electrode Ø 0.5 mm; 50,0 mm long; (10N21)	10 Pcs.	2007
702.0006	Collet for electrode Ø 1.0 mm; 50,0 mm long; (10N22)	10 Pcs.	2007

Spare Parts List (numerical)

Ident-No.	Description	Units	Product-group
702.0007	Collet for electrode Ø 1.2 mm; 50.0 mm long	10 Pcs.	2007
702.0008	Collet for electrode Ø 1.6 mm; 50.0 mm long; (10N23)	10 Pcs.	2007
702.0009	Collet for electrode Ø 2.4 mm; 50.0 mm long; (10N24)	10 Pcs.	2007
702.0010	Collet for electrode Ø 3.2 mm; 50.0 mm long; (10N25)	10 Pcs.	2007
702.0011	Collet for electrode Ø 4.0 mm; 50.0 mm long; (54N20)	10 Pcs.	2007
702.0012	Collet for electrode Ø 2.0 mm; 50.0 mm long	10 Pcs.	2007
702.0055	Insulating ring	10 Pcs.	2003
703.0001	Torch body SR / ABITIG® GRIP Little 9 F (flexible); 46.0 mm long		2002
703.0009	Torch body SR / ABITIG® GRIP Little 17 F (flexible); 60.0 mm long		2002
703.0010	Torch body ABITIG® 17 FV (flexible); 80.0 mm long		2002
703.0012	Insulating ring	10 Pcs.	2003
703.0290	Torch body ABITIG® 26 FV (flexible); 80.0 mm long		2002
703.0302	Torch body SR / ABITIG® GRIP Little 20 F (flexible); 46.0 mm long		2002
703.0305	Torch body SR / ABITIG® GRIP Little 20 F (flexible); 75.0 mm long		2002
703.0306	Torch body SR / ABITIG® GRIP Little 20 F (flexible); 110.0 mm long		2002
704.0046	Ceramic gas nozzle; no. 4; Ø 6.5 mm; 43.0 mm long	10 Pcs.	2004
704.0047	Ceramic gas nozzle; no. 5; Ø 8.0 mm; 43.0 mm long	10 Pcs.	2004
704.0048	Ceramic gas nozzle; no. 6; Ø 9.5 mm; 43.0 mm long	10 Pcs.	2004
704.0049	Ceramic gas nozzle; no. 7; Ø 11.0 mm; 43.0 mm long	10 Pcs.	2004
704.0050	Ceramic gas nozzle; no. 8; Ø 12.5 mm; 43.0 mm long	10 Pcs.	2004
704.0051	Ceramic gas nozzle; no. 9; Ø 14.5 mm; 43.0 mm long	10 Pcs.	2004
704.0052	Ceramic gas nozzle; no. 10; Ø 16.0 mm; 48.0 mm long	10 Pcs.	2004
704.0053	Ceramic gas nozzle; no. 11; Ø 17.5 mm	10 Pcs.	2004
705.0001	Torch body SR / ABITIG® GRIP Little 9; 46.0 mm long		2002
705.0007	Torch body ABITIG® 9 V; 60.0 mm long		2002
705.0033	Torch body SR / ABITIG® GRIP Little 17; 65.0 mm long		2002
705.0038	Torch body ABITIG® 17 V; 65.0 mm long		2002
705.0046	Valve ABITIG® 9 V / 17 V / 17 FV		2005
705.0058	Torch body SR / ABITIG® GRIP Little 20; 46.0 mm long		2002
705.0075	Torch body SR / ABITIG® GRIP Little 24 G; 55.0 mm long		2002
705.0080	Torch body SR / ABITIG® GRIP Little 24 W; 55.0 mm long		2002
705.0091	Torch body ABITIG® 26 V; 80.0 mm long		2002
705.0096	Handle tube		2005
705.0097	Valve ABITIG® 26 V / 26 FV		2005
705.1440	Handle tube ABITIG® 9 V / ABITIG® 17 V / ABITIG® 17 FV		2005
705.1519	Component kit for electrode WE-Ø 1.6		2005
705.1520	Component kit for electrode WE-Ø 2.4		2005
706.1037	ABITIG® 17 V; with valve; plug 35-50; 4.00 m long		2012
706.1038	ABITIG® 17 V; with valve; plug 35-50; 8.00 m long		2012
706.1057	ABITIG® 17 V; with valve; plug 10-25; 4.00 m long		2012
706.1058	ABITIG® 17 V; with valve; plug 10-25; 8.00 m long		2012
706.1137	ABITIG® 17 FV; with valve; plug 35-50; 4.00 m long		2012
706.1138	ABITIG® 17 FV; with valve; plug 35-50; 8.00 m long		2012
706.1157	ABITIG® 17 FV; with valve; plug 10-25; 4.00 m long		2012
706.1158	ABITIG® 17 FV; with valve; plug 10-25; 8.00 m long		2012
706.4037	ABITIG® 26 V; with valve; plug 35-50; 4.00 m long		2012
706.4038	ABITIG® 26 V; with valve; plug 35-50; 8.00 m long		2012
706.4137	ABITIG® 26 FV; with valve; plug 35-50; 4.00 m long		2012
706.4138	ABITIG® 26 FV; with valve; plug 35-50; 8.00 m long		2012
706.5057	ABITIG® 9 V; with valve; plug 10-25; 4.00 m long		2012
706.5058	ABITIG® 9 V; with valve; plug 10-25; 8.00 m long		2012
710.0014	Coupling nut G 1/8"	10 Pcs.	9010
712.0020	Torch body ABITIG® GRIP 12-1; 70.0 mm long		2002
712.0051	Back cap, long		2009
712.0053	Back cap, short		2009
712.0062	Collet for electrode Ø 1.6 mm; 64.0 mm long	10 Pcs.	2007

Spare Parts List (numerical)

Ident-No.	Description	Units	Product-group
712.0063	Collet for electrode Ø 2.4 mm; 64.0 mm long	10 Pcs.	2007
712.0064	Collet for electrode Ø 3.2 mm; 64.0 mm long	10 Pcs.	2007
712.0065	Collet for electrode Ø 4.0 mm; 64.0 mm long	10 Pcs.	2007
712.0072	Collet body for electrode Ø 1.6 mm	10 Pcs.	2008
712.0073	Collet body for electrode Ø 2.4 mm	10 Pcs.	2008
712.0074	Collet body for electrode Ø 3.2 mm	10 Pcs.	2008
712.0075	Collet body for electrode Ø 4.0 mm	10 Pcs.	2008
712.0101	Collet body for electrode with gas lens Ø 1.6 mm		2016
712.0102	Collet body for electrode with gas lens Ø 2.4 mm		2016
712.0103	Collet body for electrode with gas lens Ø 3.2 mm		2016
712.0104	Collet body for electrode with gas lens Ø 4.0 mm		2016
712.0152	Component kit for electrode WE-Ø 2.4		2005
712.0153	Component kit for electrode WE-Ø 3.2		2005
712.0192	Component kit for electrode gas lens WE-Ø 2.4		2005
712.1020	Torch body ABITIG® GRIP 17; 65.0 mm long		2002
712.1030	Torch body ABITIG® GRIP 17 F (flexible); 65.0 mm long		2002
712.1051	Back cap, long	10 Pcs.	2009
712.1053	Back cap, short	10 Pcs.	2009
712.2020	Torch body ABITIG® GRIP 18; 69.0 mm long		2002
712.2030	Torch body ABITIG® GRIP 18 F (flexible); 69.0 mm long		2002
712.2151	Component kit for electrode WE-Ø 1.6		2005
712.2152	Component kit for electrode WE-Ø 2.4		2005
712.2153	Component kit for electrode WE-Ø 3.2		2005
712.2191	Component kit for electrode gas lens WE-Ø 1.6		2005
712.2192	Component kit for electrode gas lens WE-Ø 2.4		2005
712.2193	Component kit for electrode gas lens WE-Ø 3.2		2005
712.2230	Torch body ABITIG® GRIP 18 K (short); 59.0 mm long		2002
712.3020	Torch body ABITIG® GRIP 20; 46.0 mm long		2002
712.3030	Torch body ABITIG® GRIP 20 F (flexible); 46.0 mm long		2002
712.3151	Component kit for electrode WE-Ø 1.6		2005
712.3191	Component kit for electrode gas lens WE-Ø 1.6		2005
712.4020	Torch body ABITIG® GRIP 26; 79.0 mm long		2002
712.4030	Torch body ABITIG® GRIP 26 F (flexible); 79.0 mm long		2002
712.4230	Torch body ABITIG® GRIP 26 K (short); 59.0 mm long		2002
712.5020	Torch body ABITIG® GRIP 9; 46.0 mm long		2002
712.5030	Torch body ABITIG® GRIP 9 F (flexible); 46.0 mm long		2002
712.6020	Torch body ABITIG® GRIP 18 SC; 75.0 mm long		2002
712.6043	Insulating ring	5 Pcs.	2003
712.6064	Collet for electrode HL Ø 3.2 mm; 49.0 mm long; (10N25HD)	10 Pcs.	2007
712.6065	Collet for electrode HL Ø 4.0 mm; 49.0 mm long; (54N20HD)	10 Pcs.	2007
712.6066	Collet for electrode HL Ø 4.8 mm; 49.0 mm long; (18C36)	10 Pcs.	2007
712.6074	Collet body for electrode Ø 0.5 - 3.2 mm; (NCB-53)		2008
712.6076	Collet body for electrode HL Ø 3.2 - 4.8 mm; (NCB-36)		2008
712.6099	Collet body for electrode with gas lens Ø 0.5 mm; (18GL02)		2016
712.6100	Collet body for electrode with gas lens Ø 1.0 mm; (18GL04)		2016
712.6101	Collet body for electrode with gas lens Ø 1,6 mm; (18GL16)		2016
712.6102	Collet body for electrode with gas lens Ø 2.4 mm; (18GL32)		2016
712.6103	Collet body for electrode with gas lens Ø 3.2 mm; (18GL18)		2016
712.6104	Collet body for electrode with gas lens Ø 4.0 mm; (18GL53)		2016
712.6105	Collet body for electrode with gas lens Ø 4.8 mm; (18GL36)		2016
712.6152	Component kit for electrode WE-Ø 2.4		2005
712.6153	Component kit for electrode HL WE-Ø 3.2		2005
712.6192	Component kit for electrode gas lens WE-Ø 2.4		2005
712.6193	Component kit for electrode HL gas lens WE-Ø 3.2		2005
712.7020	Torch body ABITIG® GRIP 24 G; 55,0 mm long		2002
712.7026	Socket		2005

Spare Parts List (numerical)

Ident-No.	Description	Units	Product-group
712.7120	Torch body ABITIG® GRIP 24 W; 55,0 mm long		2002
717.0014	Powerfitting 3/8"-24G		2005
717.0015	Hose connector for 3/8"-24G		2005
717.0016	Hose connector for G 1/8"	10 Pcs.	2005
726.0002	Cable support 5/8"-18G		2005
729.0057	Double nipple		2101
729.0059	Cold wire feeding tip Ø 1.2 mm		2101
729.0061	Cold wire feeding tip Ø 1.0 mm		2101
729.0062	Cold wire feeding tip Ø 1.6 mm		2101
729.0071	Cold wire feeding tip Ø 0.8 mm		2101
729.0072	Cold wire feeding tip Ø 1.0 mm		2101
729.0073	Cold wire feeding tip Ø 1.2 mm		2101
729.0074	Cold wire feeding tip Ø 1.6 mm		2101
729.0080	Cold wire guide liner 2.0x4.5x45 mm		2101
729.0084	Cold wire feeding cpl. for ABITIG® 260 W		2100
749.1604	BCS-81 connecting module	10 Pcs.	9010
770.0010.1	Torch body ABITIG® GRIP Little 150; 46.0 mm long		2522
770.0081.10	Ceramic gas nozzle 32 mm; ND 6.5 mm	10 Pcs.	2541
770.0082.10	Ceramic gas nozzle 32 mm; ND 8.0 mm	10 Pcs.	2541
770.0083.10	Ceramic gas nozzle 32 mm; ND 9.5 mm	10 Pcs.	2541
770.0084.10	Ceramic gas nozzle 32 mm; ND 11.0 mm	10 Pcs.	2541
770.0130.1	Torch body ABITIG® GRIP 150 Little (flexible); 46.0 mm long		2522
770.0501	BCS-02 connecting module		2555
770.0502	BCS-01 connecting module		2555
770.0503	BCS-26 connecting module		2005
770.0516	BCS-02 connecting module		2005
770.0518	BCS-01 connecting module		2005
770.0521	BCS-20 connecting module		2555
770.0522	BCS-20 connecting module		2005
770.0523	BCS-20 connecting module		2005
770.0531	BCS-03 connecting module		2555
770.0541	BCS-04 connecting module		2555
770.0551	BCS-04 connecting module		2005
770.0557	BCS-04 connecting module		2005
770.0558	BCS-27 connecting module		2005
770.0560	Cable support machine side		2005
770.0561	BCS-05 connecting module		2555
770.0562	BCS-05 connecting module		2005
770.0571	BCS-06 connecting module		2555
770.0573	BCS-06 connecting module		2005
770.0576	BCS-34 connecting module		2005
770.0577	BCS-34 connecting module		2005
770.0581	BCS-03 connecting module		2005
770.0583	BCS-03 connecting module		2005
770.0584	BCS-36 connecting module		2005
770.0585	BCS-36 connecting module		2005
770.0586	BCS-36 connecting module		2555
770.0591	BCS-23 connecting module		2005
770.0593	BCS-37 connecting module		2005
770.0594	BCS-37 connecting module		2005
770.0595	BCS-37 connecting module		2555
770.0599	BCS-38 connecting module		2005
771.0051	Back cap, medium		2545
771.0502	Distance ring		9010
771.0509	BCS-07 connecting module		2005
771.0521	BCS-00 connecting module		2005

Spare Parts List (numerical)

Ident-No.	Description	Units	Product-group
771.0525	BCS-22 connecting module		2005
771.0562	BCS-11 connecting module		2005
771.0563	BCS-09 connecting module		2005
771.0572	BCS-08 connecting module		2005
771.0573	BCS-14 connecting module		2005
771.0574	BCS-15 connecting module		2005
771.0575	BCS-24 connecting module		2005
772.0010.1	Torch body ABITIG® GRIP Little 260 W; 46.0 mm long		2522
772.0505	Connector		2005
772.0509	BCS-07 connecting module		2005
772.0512	BCS-02 connecting module		2005
772.0514	BCS-07 connecting module		2555
772.0515	BCS-26 connecting module		2555
772.0516	BCS-26 connecting module		2005
772.0519	Cable support machine side		2005
772.0521	BCS-08 / BCS-10 connecting module		2555
772.0531	BCS-12 connecting module		2555
772.0543	Cable support machine side		2555
772.0561	BCS-15 connecting module		2555
772.0571	BCS-16 connecting module		2555
772.0581	BCS-17 connecting module		2005
772.0582	BCS-17 connecting module		2555
772.0586	BCS-12 connecting module		2005
772.0587	BCS-16 connecting module		2005
772.0591	BCS-19 connecting module		2555
772.0597	Adaptor nut		2005
773.0051	Back cap, long		2545
773.0053	Back cap, short		2545
773.0171	Gas diffuser for electrode WE-Ø 1.0 mm		2548
773.0172	Gas diffuser for electrode WE-Ø 1.6 mm		2548
773.0173	Gas diffuser for electrode WE-Ø 2.4 mm		2548
773.0174	Gas diffuser for electrode WE-Ø 3.2 mm		2548
773.0175	Gas diffuser for electrode WE-Ø 4.0 mm		2548
773.0176	Gas diffuser for electrode WE-Ø 4.8 mm		2548
773.0177	Gas diffuser for electrode WE-Ø 2.0 mm		2548
773.0501	BCS-18 connecting module		2005
773.0511	BCS-19 connecting module		2005
773.0519	Nipple		2005
773.0531	BCS-21 connecting module		2555
773.0534	BCS-21 connecting module		2005
773.0536	BCS-25 connecting module		2005
773.0537	BCS-33 connecting module		2005
773.0538	BCS-33 connecting module		2555
773.0551	BCS-25 connecting module		2005
773.0553	BCS-25 connecting module		2555
773.0556	BCS-33 connecting module		2005
773.0558	BCS-35 connecting module		2005
773.0559	BCS-35 connecting module		2555
774.0010	Torch body ABITIG® GRIP 200; 80.0 mm long		2522
774.0130	Torch body ABITIG® GRIP 200 F (flexible); 80.0 mm long		2522
774.0183	Component kit standard for electrode WE-Ø 2.4		2550
774.0184	Component kit standard for electrode WE-Ø 3.2		2550
774.0186	Component kit standard for electrode WE-Ø 4.8		2550
774.0193	Component kit gas diffusor for electrode WE-Ø 2.4		2550
774.0194	Component kit gas diffusor for electrode WE-Ø 3.2		2550
774.0196	Component kit gas diffusor for electrode WE-Ø 4.8		2550

Spare Parts List (numerical)

Ident-No.	Description	Units	Product-group
774.0230	Torch body ABITIG® GRIP 200 K (short); 60.0 mm long		2522
775.0010	Torch body ABITIG® GRIP 450 W; 80.0 mm long		2522
775.0062	Electrode holder for electrode WE Ø 1.6 mm	5 Pcs.	2548
775.0063	Electrode holder for electrode WE Ø 2.4 mm	5 Pcs.	2548
775.0064	Electrode holder for electrode WE Ø 3.2 mm	5 Pcs.	2548
775.0065	Electrode holder for electrode WE Ø 4.0 mm	5 Pcs.	2548
775.0066	Electrode holder for electrode WE Ø 4.8 mm	5 Pcs.	2548
775.0067	Electrode holder for electrode WE Ø 2.0 mm	5 Pcs.	2548
775.0081	Ceramic gas nozzle 37.4 mm; ND 7.5 mm	10 Pcs.	2541
775.0082	Ceramic gas nozzle 37.4 mm; ND 10.5 mm	10 Pcs.	2541
775.0083	Ceramic gas nozzle 37.4 mm; ND 13.0 mm	10 Pcs.	2541
775.0084	Ceramic gas nozzle 37.4 mm; ND 15.0 mm	10 Pcs.	2541
775.0108	Retaining ring		2555
775.0122	Gas diffuser 4 for electrode WE-Ø 1.6 mm		2548
775.0123	Gas diffuser 4 for electrode WE-Ø 2.4 mm		2548
775.0124	Gas diffuser 4 for electrode WE-Ø 3.2 mm		2548
775.0125	Gas diffuser 4 for electrode WE-Ø 4.0 mm		2548
775.0126	Gas diffuser 4 for electrode WE-Ø 4.8 mm		2548
775.0152	Ceramic gas nozzle 26.6 mm; ND 10.0 mm	10 Pcs.	2541
775.0153	Ceramic gas nozzle 26.6 mm; ND 13.0 mm	10 Pcs.	2541
775.0183	Ceramic gas nozzle 38.4 mm; ND 13.0 mm (reenforced)	10 Pcs.	2541
775.0184	Ceramic gas nozzle 38.4 mm; ND 15.0 mm (reenforced)	10 Pcs.	2541
775.0230	Torch body ABITIG® GRIP 450 W K (short); 60.0 mm long		2522
775.1043	Insulator		2555
775.1143	Insulator for gas diffusor 4		2555
775.1341	Cable support spring		2555
775.2171	Ceramic gas nozzle 51.5 mm; ND 7.5 mm	10 Pcs.	2541
775.2172	Ceramic gas nozzle 51.5 mm; ND 10.0 mm	10 Pcs.	2541
775.2173	Ceramic gas nozzle 51.5 mm; ND 13.0 mm	10 Pcs.	2541
775.2174	Ceramic gas nozzle 51.5 mm; ND 16.0 mm	10 Pcs.	2541
775.2541	ABITIG® 450 W with cold wire feed (4.00 m; BIS-25; BHC-12; WZ-2)		2502
776.0010	Torch body ABITIG® GRIP 150; 60.0 mm long		2522
776.0051	Back cap, long		2545
776.0053	Back cap, short		2545
776.0061	Electrode holder for electrode WE Ø 1.0 mm	5 Pcs.	2548
776.0062	Electrode holder for electrode WE Ø 1.6 mm	5 Pcs.	2548
776.0063	Electrode holder for electrode WE Ø 2.4 mm	5 Pcs.	2548
776.0064	Electrode holder for electrode WE Ø 3.2 mm	5 Pcs.	2548
776.0067	Electrode holder for electrode WE Ø 2.0 mm	5 Pcs.	2548
776.0130	Torch body ABITIG® GRIP 150 F (flexible); 60.0 mm long		2522
776.0171	Gas diffuser for electrode WE-Ø 1.0 mm		2548
776.0172	Gas diffuser for electrode WE-Ø 1.6 mm		2548
776.0173	Gas diffuser for electrode WE-Ø 2.4 mm		2548
776.0174	Gas diffuser for electrode WE-Ø 3.2 mm		2548
776.0177	Gas diffuser for electrode WE-Ø 2.0 mm		2548
776.0441	Adaptor ring		2555
776.0443	Insulator for gas diffuser 4		2555
776.1043	Insulator	10 Pcs.	2555
777.0010	Torch body ABITIG® GRIP 260 W; 60.0 mm long		2522
777.0081	Ceramic gas nozzle 26 mm; ND 6.5 mm	10 Pcs.	2541
777.0082	Ceramic gas nozzle 26 mm; ND 8.0 mm	10 Pcs.	2541
777.0083	Ceramic gas nozzle 26 mm; ND 9.5 mm	10 Pcs.	2541
777.0084	Ceramic gas nozzle 26 mm; ND 11.0 mm	10 Pcs.	2541
777.0182	Component kit standard for electrode WE-Ø 1.6		2550
777.0183	Component kit standard for electrode WE-Ø 2.4		2550
777.0184	Component kit standard for electrode WE-Ø 3.2		2550

Spare Parts List (numerical)

Ident-No.	Description	Units	Product-group
777.0192	Component kit gas diffusor for electrode WE-Ø 1.6		2550
777.0193	Component kit gas diffusor for electrode WE-Ø 2.4		2550
777.0194	Component kit gas diffusor for electrode WE-Ø 3.2		2550
777.2005	ABITIG® 260 W with cold wire feed (4.00 m; BIS-25; BHC-12; WZ-2)		2502
777.2171	Ceramic gas nozzle 36 mm; ND 6.5 mm	10 Pcs.	2541
777.2172	Ceramic gas nozzle 36 mm; ND 8.0 mm	10 Pcs.	2541
777.2173	Ceramic gas nozzle 36 mm; ND 9.5 mm	10 Pcs.	2541
777.2174	Ceramic gas nozzle 36 mm; ND 11.0 mm	10 Pcs.	2541
777.2175	Ceramic gas nozzle 60 mm; ND 6.5 mm	10 Pcs.	2541
777.2176	Ceramic gas nozzle 60 mm; ND 8.0 mm	10 Pcs.	2541
778.1020	Torch body ABITIG® 150 MT		2532
778.1030	Guide tube cpl. ABITIG® 200 MT / ABITIG® 300 W MT		2555
778.1109	Sieve		2555
778.1140	Collet		2555
778.1142	Adaptor part WE-Ø 1.6 mm		2555
778.1143	Adaptor part WE-Ø 2.4 mm		2555
778.1144	Adaptor part WE-Ø 3.2 mm		2555
778.1145	Adaptor part WE-Ø 4.0 mm		2555
778.1146	Adaptor part WE-Ø 4.8 mm		2555
778.1148	Gas diffuser 4-MT for electrode WE-Ø 1.6 - 4.8 mm		2548
778.1157	Alignment jig ABITIG® MT		2555
778.1183	Ceramic gas nozzle 50 mm; ND 12.5 mm	10 Pcs.	2541
778.1184	Ceramic gas nozzle 50 mm; ND 16.0 mm	10 Pcs.	2541
778.1185	Ceramic adaptor		2541
778.1186	Gas nozzle metal 48 mm; ND 16.0 mm		2541
778.1187	Gas nozzle metal 48 mm; ND 19.0 mm		2541
778.1188	Ceramic gas nozzle 50 mm; ND 19.5 mm	10 Pcs.	2541
778.1189	Ceramic gas nozzle 34 mm; ND 24.0 mm	10 Pcs.	2541
778.2020	Torch body ABITIG® 200 MT		2532
779.1020	Torch body ABITIG® 260 W MT		2532
779.1030	Guide tube cpl. ABITIG® 150 MT / ABITIG® 260 W MT		2555
779.1043	Insulator		2555
779.2020	Torch body ABITIG® 300 W MT		2532
779.4020	Torch body ABITIG® 400 W MT		2532
779.4030	Guide tube cpl. ABITIG® 400 W MT		2555
779.4043	Insulator		2555
779.6020	Torch body ABITIG® 500 W MT		2532
779.6026	Guide tube cpl. ABITIG® 500 W MT		2555
779.6033	Insulator		2555
779.6044	Electrode holder for electrode WE Ø 1.6 mm		2548
779.6045	Electrode holder for electrode WE Ø 2.4 mm		2548
779.6046	Electrode holder for electrode WE Ø 3.2 mm		2548
779.6047	Electrode holder for electrode WE Ø 4.0 mm		2548
779.6048	Electrode holder for electrode WE Ø 4.8 mm		2548
779.6049	Electrode holder for electrode WE Ø 2.0 mm		2548
779.6050	Electrode holder for electrode WE Ø 6.4 mm		2548
779.6058	Gas diffuser for electrode WE-Ø 1.6 mm		2548
779.6059	Gas diffuser for electrode WE-Ø 2.4 mm		2548
779.6060	Gas diffuser for electrode WE-Ø 3.2 mm		2548
779.6061	Gas diffuser for electrode WE-Ø 4.0 mm		2548
779.6062	Gas diffuser for electrode WE-Ø 4.8 mm		2548
779.6063	Gas diffuser for electrode WE-Ø 2.0 mm		2548
779.6064	Gas diffuser for electrode WE-Ø 6.4 mm		2548
780.0145	Torch mount MT-30		5207
780.0222	Torch mount MT-25		2555
780.0258	Torch mount MT-26		5207

Notes

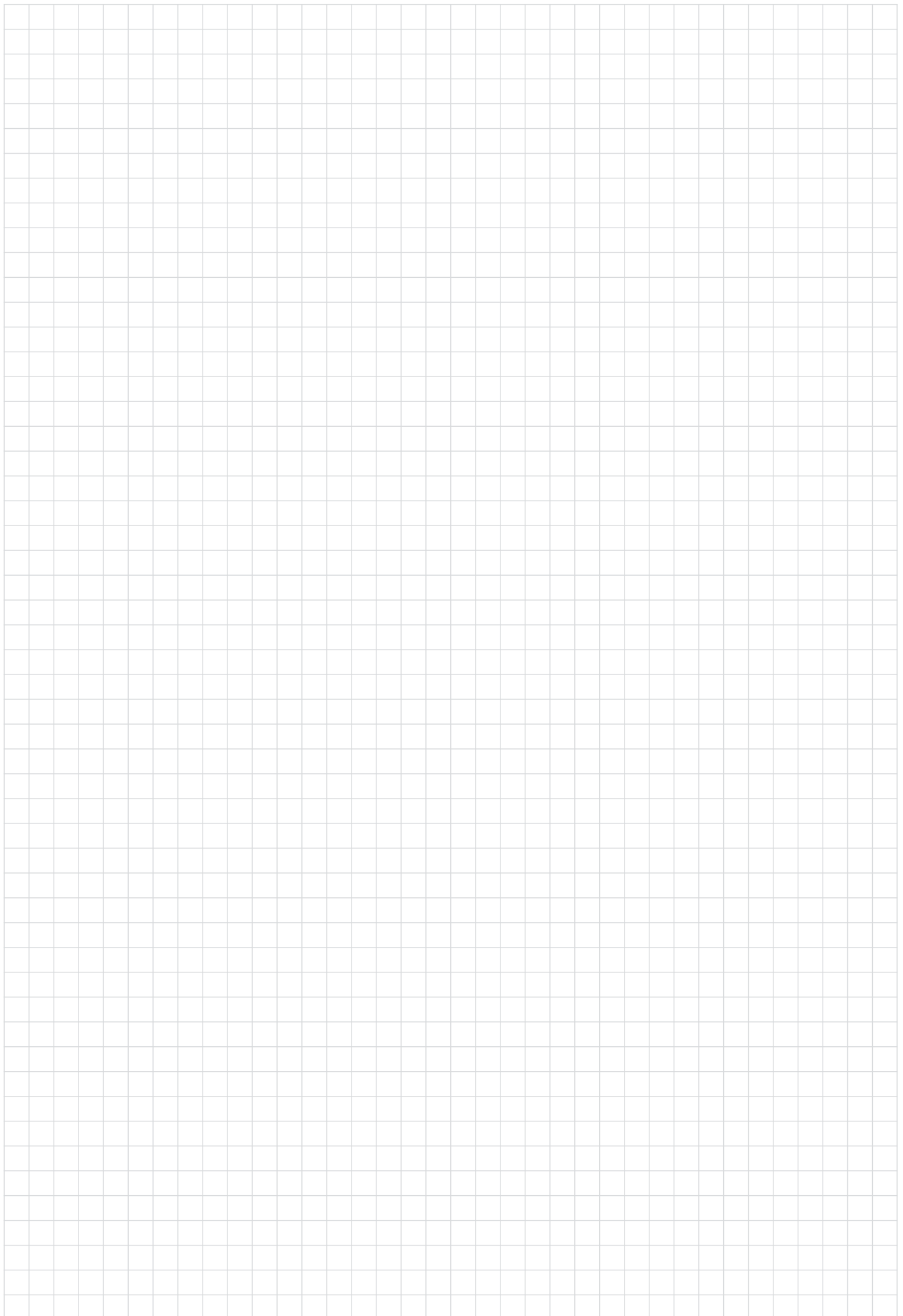

Standard Terms and Conditions of Deliveries and Services (Terms and Conditions of Sale) of Alexander Binzel Schweisstechnik GmbH & Co. KG

§ 1 Validity of the Terms and Conditions of Business

- 1.1 All our deliveries, services and tenders take place exclusively on the basis of these Standard Terms and Conditions of Deliveries and Services Payment (hereinafter called "these business conditions"). These business conditions are an element of all agreements that we conclude with our contractual partners (hereinafter called "customers").
- 1.2 The customer's Standard Terms and Conditions of Business do not apply, even if we do not contradict their validity in individual cases. Neither does reference to a letter that contains the customer's or a third party's Standard Terms and Conditions of Business, or refers to such, constitute an agreement with the validity of the aforesaid Standard Terms and Conditions of Business. They also do not become a contractual element through conclusive actions, such as the production of a performance by us.
- 1.3 The business conditions apply to all agreements on deliveries and services on our part, as well as all peripheral services. These business conditions are valid for all future deliveries and services on our part even without a separate agreement of inclusion.

§ 2 Tender and conclusion of the agreement

- 2.1 Insofar as our tenders are marked expressly as being subject to change, we can also revoke these immediately after receipt of acceptance by the customer.
- 2.2 The customer does not acquire any copyright in any tenders or cost estimates submitted by us, nor to any drawings, illustrations, calculations, descriptions, models, tools and other documents and material resources made available to him. This also applies to those materials and documents mentioned that are expressly labelled "confidential" or whose confidential character arises from the circumstances. The passing on of the abovementioned materials and documents to third parties requires at any rate our permission. The customer must ensure this by appropriate agreements with his employees or any other persons who work with knowledge and consent in his area of responsibilities. The abovementioned materials and documents must be returned immediately at the customer's expense, if an agreement does not come into being or they are no longer required for further contractual implementation.

§ 3 Prices

- 3.1 Unless otherwise stated in the order confirmation, our prices are valid "ex Works", excluding packaging; this will be charged separately.
- 3.2 Legal value-added tax is not included in our prices. It is shown separately in the invoice in the amount legally prescribed on the day of invoicing. In the case of foreign transactions, the value-added tax no longer applies; however, the recipient must pay the taxes and fees incurred for the transfer into the recipient's country, especially customs duties and the additional legal taxes or charges incurred in the recipient's country itself.
- 3.3 The deduction of a discount for cash requires a separate agreement. The customer's Standard Terms and Conditions of Business, which call for the deduction of a cash discount, do not apply.

§ 4 Implementation of the deliveries and services, delivery and service times

- 4.1 Unless otherwise agreed, the delivery takes place "ex Works".
- 4.2 The start of the delivery or service time stated by us presupposes the clarification of all technical issues.
- 4.3 Furthermore, the observance of our delivery and service obligations presupposes the customer's punctual and proper performance. We are fully entitled to the plea of non-performance.
- 4.4 If the person ordering is in default of taking delivery or infringes any other duties to cooperate, we are entitled to request replacement of any loss incurred by us in this respect, including any additional expenditure. More extensive claims remain unaffected.
- 4.5 Insofar as the conditions of § 4 (4) are met, the risk of accidental loss or unintentional deterioration of the object to be delivered passes to the customer at that point in time, when he has fallen into default of taking delivery.
- 4.6 If it has been agreed with the customer that our delivery or service does not have to take place at a fixed time, but within a certain period, we are entitled to deliver or produce our performance before the expiration of the period also. If a fixed date has been agreed with the customer, we are entitled to premature delivery or production of the performance, after having given the customer reasonable notice of this before delivery or production of the performance. This does not apply, if the delivery can only take place on the agreed date for reasons discernible for us.
- 4.7 Unless otherwise agreed, the customer, in the case of agreements that entitle him to request partial deliveries from a total quantity of goods, is obligated to give us punctual requests and assortment plans for approximate identical monthly quantities. If the customer does not request delivery punctually or does not plan in good time, we are entitled to take over the planning ourselves and to deliver the goods after a reasonable extended deadline has passed fruitlessly. If the customer fails to request delivery at all or in good time or fails to plan at all or in good time we are entitled to withdraw from the entire agreement after prior warning. Any compensation claims to which we are legally entitled remain at any rate unaffected.
- 4.8 With regard to order for goods to be delivered on demand according to § 4 (7) of these business conditions, we are entitled, unless otherwise agreed, to procure the material for the entire order and to manufacture the entire quantity ordered immediately. Requests from the customer for changes can no longer be taken into consideration after the order has been placed.
- 4.9 Increased or short deliveries are permissible in accordance with ordinary trade usage.

§ 5 Delays in delivery

- 5.1 Stoppages caused by force majeure, strikes for which we are not responsible or lock-outs or a lack of operating and/or raw materials entitle us, to withdraw from the not yet fulfilled agreement, if the abovementioned circumstances make delivery or performance impossible not only temporarily and in addition were not discernible on conclusion of the agreement.
- 5.2 If we are in delay with a delivery or service or if a delivery or service becomes impossible for us, the customer's claim for compensation is restricted subject to § 9 of these business conditions.

§ 6 Place of performance, shipment, packaging, passing of the risk

- 6.1 The place of performance for all obligations from the contractual relationship with the customer is Buseck/Alten-Buseck.
- 6.2 Unless otherwise agreed, we will select the most economical packaging known to us and the most economical type of shipment known to us.
- 6.3 Unless otherwise agreed, the risk passes to the customer at the latest with the handover of the delivered objects to the shipping contractor, carrier or other company appointed with the implementation of the consignment. § 4 (4) remains unaffected.
- 6.4 The shipment will only be insured by us against theft, breakage, damage during transport, fire and water damage or any other insurable risks at the express written request of the customer and at his expense.
- 6.5 We will only take back packaging in our storehouses (return depots). The customer pays the costs of transporting the packaging to the respective return depot. If packaging different from the standard packaging (special packaging) is used at the customer's request, the customer is obliged to recycle or dispose of this at his own expense.

§ 7 Customer's claims in case of defects or incomplete deliveries and services

- 7.1 The objects delivered by us must be carefully examined immediately after delivery to the customer or to the third party appointed by him. They are considered approved, if a complaint, that could have been discovered on careful examination, is not reported in writing within three days after

receipt of the goods, the date of sending the complaint to us being decisive. If the defect was not noticeable by careful examination, the obligation to report the complaint immediately in writing is valid from the time of discovery.

- 7.2 If a delivery or service defect exists, for which we are responsible, we are obliged, at our option, to remedy the defect or deliver a replacement. In the case of remedying the defect, we are obliged to pay all costs required to remedy the defect, in particular transport, labour and material costs, unless these are increased by the fact that the purchased object was taken to a different location than the original place of consignment. This does not apply, if transporting the delivered object to another location corresponds to its agreed use. If we select subsequent performance in the form of replacement, the delivered objects with failures must be sent back to us carriage paid, whereby the customer is obliged to select the most economical type of shipment.
- 7.3 The limitation period for claims based on quality defects. The warranty period amounts to one year and begins with the time of delivery to the customer or to a third party appointed by the customer.
- 7.4 The delivery of used objects takes place excluding any warranty whatsoever.

§ 8 Purchase of consumer goods

§ 7 (3) does not apply, if the newly manufactured objects delivered by us are sold to consumers, also within the context of a chain of suppliers.

§ 9 Compensatory damages

- 9.1 We are only liable - regardless of for which legal reason - for the wilful and gross negligent conduct of our agencies and vicarious agents as well as - without regard to the degree of culpability - for damages from injury to life, body or health.
- 9.2 We are also responsible for slight negligence by our agencies and vicarious agents in the event of delay in performance or infringement of any other cardinal duty. In such a case our liability is restricted to damage that has to be reasonably expected when concluding such an agreement.
- 9.3 All limitations of liability also apply in the event that the infringement of contractual duties simultaneously represents an actionable tort.

§ 10 Reservation of ownership

- 10.1 We retain the right to ownership of the delivered object until all payments from the delivery agreement have been received. In the event of breach of contract by the customer, especially in the case of default of payment, we are entitled to take the delivered object back after a reasonable extended deadline has passed fruitlessly. Taking back the delivered object does not signify a withdrawal from the agreement, unless expressly declared by us in writing. The seizure of the delivered goods/object by us invariably represents a withdrawal from the agreement. After repossessing taking back the delivered goods/object, we are authorised to sell them; the proceeds from the sale will be deducted from the customer's liabilities - minus reasonable realisation costs.
- 10.2 The customer is obliged to keep the delivered objects in safe custody for us and to treat them with care.
- 10.3 In the event of seizures or any other third-party encroachments on our delivered objects, the customer must notify us immediately in writing so that we can take legal action according to § 771 Civil Procedure Rules (ZPO). If the third party is not in a position to refund us the legal and out-of-court costs of a lawsuit according to § 771 ZPO, the customer person ordering is liable for the loss incurred by us.
- 10.4 The customer is entitled to re-sell the delivered object in the normal course of business; however, he now already assigns us all demands amounting to the final invoice amount (including value-added tax) of our demand arising against his customers or third parties from the resale, regardless of whether the delivered object is re-sold with or without processing. The customer is also authorised to collect this demand after the assignment. Our authorisation to collect the demand ourselves remains unaffected by this. However, we agree not to collect the demand as long as the customer fulfils his payment obligations from the collected revenue, does not fall behind in his payments, and in particular no application for commencement of insolvency proceedings has been filed or there is a suspension of payments. However, if this is the case, we can request that the customer informs us of the assigned demands and their debtor immediately, gives us all details necessary for their collection, hands over the relevant documentation and notifies the debtor (third party) of the assignment immediately and informs us thereof by means of a copy/accompanying letter.
- 10.5 The processing or transformation of the delivered objects by the customer will always be carried out on our behalf by us. If the delivered object is processed with other objects that do not belong to us, we acquire co-ownership of the new object in the ratio of the value of the delivered object (final invoice amount including value-added tax) to the other processed objects at the time of processing. The same provisions apply otherwise for the object created by the aforesaid processing as for the object delivered with reservations.
- 10.6 If the delivered object is inseparably mixed with other objects that do not belong to us, we acquire co-ownership of the new object in the ratio of the value of the delivered object (final invoice amount including value-added tax) to the other mixed objects at the time of mixing. If the mixing takes place in a way in which the customer's object is to be regarded as the main object, it is considered agreed that the customer will transfer proportionate co-ownership to us. The customer will safeguard the created sole ownership or co-ownership for us.
- 10.7 At the customer's request, we undertake to release the securities to which we are entitled insofar as the feasible value of our securities exceeds the demands to be safeguarded by more than 10 %; we are entitled to select the securities to be released.

§ 11 Terms of payment

- 11.1 Unless otherwise agreed, our invoice amounts are payable within 30 days without any deduction. On expiration of this deadline, the customer is in default of payment without a warning on our part being required.
- 11.2 The customer may not exercise any right of set-off unless his/its counterclaim shall be undisputed or conclusively ruled upon. The same applies to the assertion of a right of retention.

§ 12 Written form and final provisions

- 12.1 Any regulations deviating from these business conditions require the written form. This does not apply to regulations, which have been agreed from our side with Managing Directors or authorised signatories.
- 12.2 The legal venue for any disputes from the business relationship between us and the customer is Gießen. However, we are also entitled to take legal action against the customer at his standard legal venue as well as at the location to which the delivered object was sent at the customer's request.
- 12.3 All legal relationships in connection with entering in, performing under or termination of this agreement shall be governed and construed in all respects in accordance with the laws of the Federal Republic of Germany with the exclusion of the Convention on Contracts for the International Sale of Goods (CISG). This also applies, if the legal relationships arise from tort or based on any other legal bases.

Our product range:

■ MIG/MAG

- Welding Torches
- Machine and Special Torches
- Push-Pull Welding Torches
- Fume Extraction Torches
- Central Adaptor System

■ TIG

- Welding Torches
- Machine and Special Torches

■ PLASMA

- Cutting Torches
- Welding Torches
- Machine and Special Torches

■ Robotic Peripheral Equipment

- Robot Torches
MIG/TIG/Plasma
- Robot Mount CAT2/iCAT
- Torch Change System
ATS-Rotor
- Tool Change System WWS
- Wire Cutting Station DAV
- Torch Cleaning Station
BRS-LC, BRS-CC and BRS-FP
- Wire Feeding Station APD-MF

■ Welding Accessories

- Coolers
- Welding Cable Plug and Socket
- Anti Spatter Spray and Paste
and so on ...



Alexander Binzel Schweisstechnik GmbH & Co. KG
 P.O. Box 10 01 53 · D-35331 Gießen
 Phone: +49 (0) 64 08 / 59-0
 Fax: +49 (0) 64 08 / 59-191
 Email: info@binzel-abicor.com

www.binzel-abicor.com